

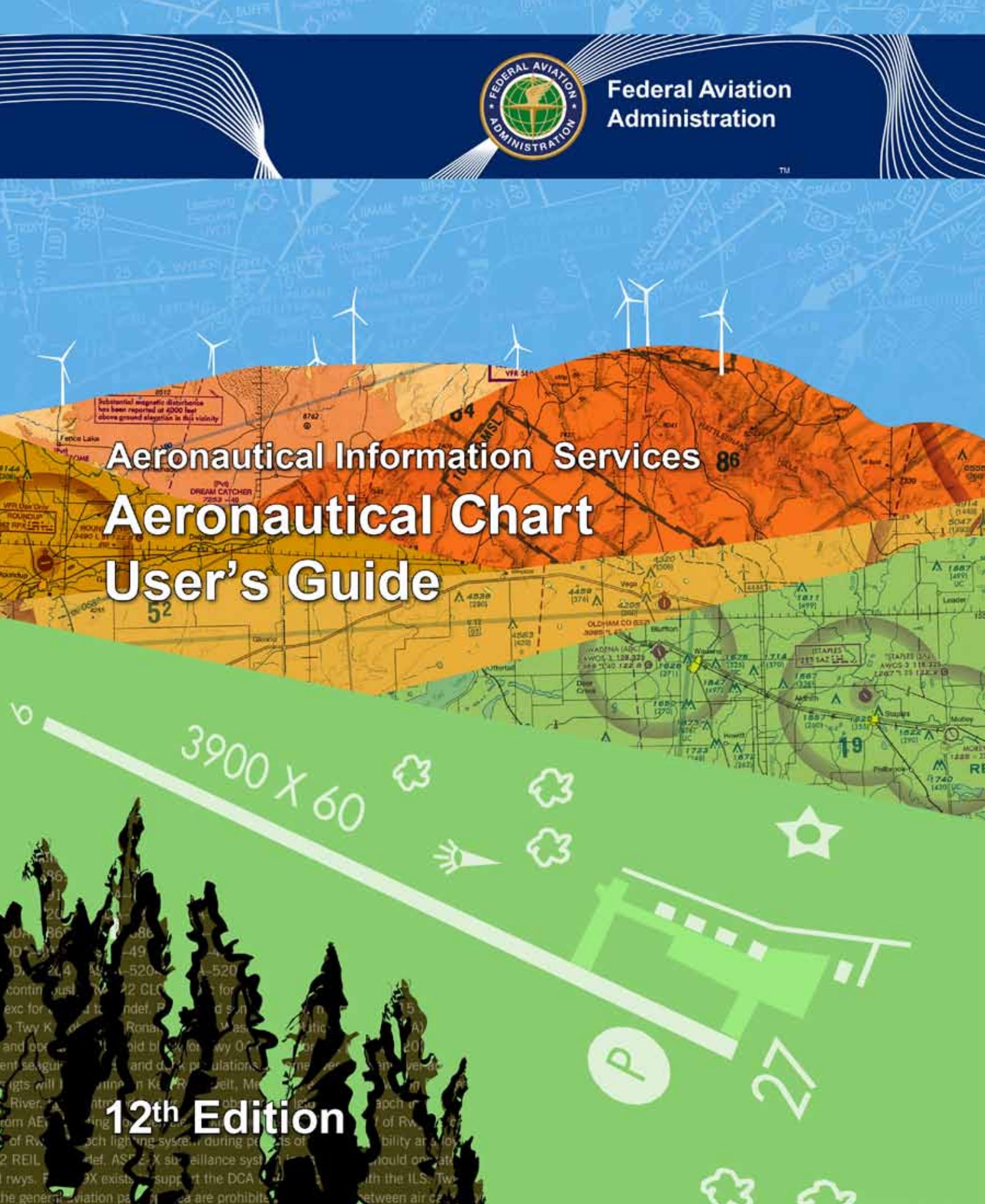

Federal Aviation
Administration

TM

The background of the cover is a composite image. The top portion shows a blue sky with white wind turbines. Below this is a topographic map with orange and yellow terrain. The bottom portion is a green field with a white runway and various navigation symbols like stars and clovers. The title text is overlaid on the map and field sections.

Aeronautical Information Services Aeronautical Chart User's Guide

12th Edition

**Aeronautical Information Services (AIS)
For More Information on FAA Aeronautical Charts:**

aeronav.faa.gov

**Purchase FAA Aeronautical Charts and Publications from authorized
Aeronautical Chart Agents located at or near many civil airports.**

Locate one in your area at:

aeronav.faa.gov

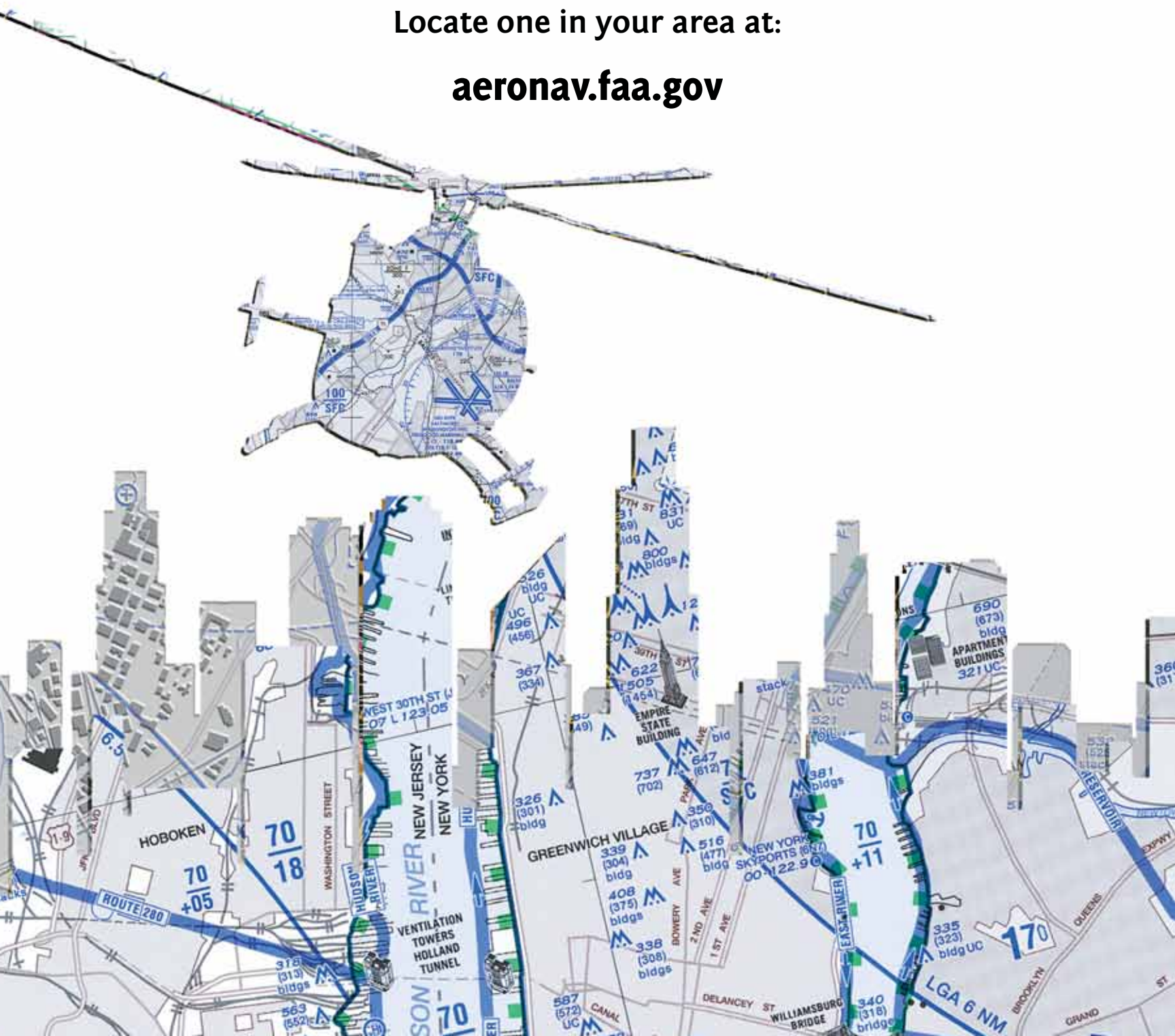



FAA Aeronautical Chart User's Guide

12th EDITION OCTOBER 2013

- INTRODUCTION..... 5
- KEEP YOUR CHARTS CURRENT..... 5
- REPORTING CHART DISCREPANCIES..... 5
- SECTION 1: VISUAL FLIGHT RULES (VFR) CHARTS
 - EXPLANATION OF VFR TERMS AND SYMBOLS..... 6
 - WATER FEATURES (HYDROGRAPHY)..... 6
 - LAND FEATURES (TERRAIN) AND OBSTRUCTIONS..... 6
 - RADIO AIDS TO NAVIGATION..... 8
 - AIRPORTS..... 8
 - CONTROLLED AIRSPACE..... 9
 - UNCONTROLLED AIRSPACE..... 10
 - SPECIAL USE AIRSPACE..... 10
 - OTHER AIRSPACE AREAS..... 10
 - TERMINAL AREA CHART (TAC) COVERAGE..... 11
 - INSET COVERAGE..... 11
 - CHART TABULATIONS..... 12
 - VFR AERONAUTICAL CHART SYMBOLS..... 14**
 - AIRPORTS..... 15
 - RADIO AIDS TO NAVIGATION..... 17
 - AIRSPACE INFORMATION..... 19
 - NAVIGATIONAL AND PROCEDURAL INFORMATION..... 25
 - CHART LIMITS..... 27
 - RAILROADS..... 28
 - ROADS..... 28
 - POPULATED PLACES..... 29
 - BOUNDARIES..... 29
 - MISCELLANEOUS CULTURAL FEATURES..... 30
 - SHORELINES..... 31
 - LAKES..... 31
 - RESERVOIRS..... 31
 - STREAMS..... 31
 - MISCELLANEOUS HYDROGRAPHIC FEATURES..... 32
 - CONTOURS..... 35
 - ELEVATIONS..... 35
 - UNRELIABLE RELIEF..... 35
 - SHADED RELIEF..... 36
 - AREA RELIEF FEATURES..... 36
 - MISCELLANEOUS RELIEF FEATURES..... 36
 - HELICOPTER ROUTE CHARTS..... 37**
 - AIRPORTS..... 38
 - RADIO AIDS TO NAVIGATION..... 38
 - AIRSPACE INFORMATION..... 39
 - NAVIGATIONAL AND PROCEDURAL INFORMATION..... 42
 - CULTURE..... 43
 - HYDROGRAPHY..... 43
 - RELIEF..... 43
 - VFR FLYWAY PLANNING CHARTS..... 44**
 - AIRPORTS..... 45
 - RADIO AIDS TO NAVIGATION..... 45

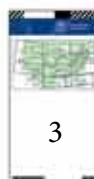



AIRSPACE INFORMATION.....	46
NAVIGATIONAL AND PROCEDURAL INFORMATION.....	48
CULTURE.....	49
HYDROGRAPHY.....	49
RELIEF.....	49
AIRSPACE CLASSES.....	50
SECTION 2: INSTRUMENT FLIGHT RULES (IFR) ENROUTE CHARTS	
EXPLANATION OF IFR ENROUTE TERMS AND SYMBOLS.....	52
AIRPORTS.....	53
RADIO AIDS TO NAVIGATION (NAVAIDs).....	54
CONTROLLED AIRSPACE.....	54
SPECIAL USE AIRSPACE.....	55
OTHER AIRSPACE.....	55
INSTRUMENT AIRWAYS.....	55
VOR LF/MF AIRWAY SYSTEM (LOW ALTITUDE ENROUTE CHARTS).....	55
AIRWAY/ROUTE DATA.....	55
AREA NAVIGATION (RNAV) "T" ROUTE SYSTEM.....	56
OFF ROUTE OBSTRUCTION CLEARANCE ALTITUDE (OROCA).....	56
MILITARY TRAINING ROUTES (MTRs).....	56
JET ROUTE SYSTEM (HIGH ALTITUDE ENROUTE CHARTS).....	57
RNAV "Q" ROUTE SYSTEM (HIGH ALTITUDE ENROUTE CHARTS).....	57
AREA NAVIGATION (RNAV) "Q" ROUTE SYSTEM (HIGH ALTITUDE CHARTS).....	57
TERRAIN CONTOURS ON AREA CHARTS.....	57
IFR AERONAUTICAL CHART SYMBOLS.....	58
IFR ENROUTE LOW/HIGH ALTITUDE CHARTS.....	59
AIRPORTS.....	59
RADIO AIDS TO NAVIGATION.....	60
AIRSPACE INFORMATION.....	61
NAVIGATIONAL AND PROCEDURAL INFORMATION.....	66
CULTURE.....	67
HYDROGRAPHY.....	67
TOPOGRAPHY.....	67
OCEANIC ROUTE PLANNING CHARTS.....	68
AIRPORTS.....	68
RADIO AIDS TO NAVIGATION.....	68
AIRSPACE INFORMATION.....	68
NAVIGATIONAL AND PROCEDURAL INFORMATION.....	69
CULTURAL BOUNDARIES.....	70
HYDROGRAPHY.....	70
SECTION 3: TERMINAL PROCEDURES PUBLICATION (TPP)	
EXPLANATION OF TPP TERMS AND SYMBOLS.....	72
PILOT BRIEFING INFORMATION.....	72
PLANVIEW.....	73
MISSED APPROACH ICONS.....	73
IFR LANDING MINIMA.....	73
TERMINAL ARRIVAL AREAS (TAAs).....	74
INSTRUMENT APPROACH CHART FORMAT.....	75
TERMINAL PROCEDURES PUBLICATION SYMBOLS.....	76
STANDARD TERMINAL ARRIVAL (STAR) CHARTS.....	77
DEPARTURE PROCEDURE (DP) CHARTS.....	77
APPROACH LIGHTING SYSTEM.....	78
AIRPORT DIAGRAM/SKETCH.....	81
INSTRUMENT APPROACH PROCEDURES PLANVIEW.....	83
INSTRUMENT APPROACH PROCEDURES PROFILE VIEW.....	85





INTRODUCTION

This Chart User's Guide is an introduction to the Federal Aviation Administration's (FAA) aeronautical charts and publications. It is useful to new pilots as a learning aid, and to experienced pilots as a quick reference guide.

The FAA publishes charts for each stage of Visual Flight Rules (VFR) and Instrument Flight Rules (IFR) air navigation including training, planning, and departures, enroute (for low and high altitudes), approaches, and taxiing charts. For Procurement, contact an Authorized FAA Chart Sales Agent. Visit our website at <http://aeronav.faa.gov> and click on "Chart Agent Locator." For digital products, visit <http://faacharts.faa.gov>.

The FAA Aeronautical Information Manual (AIM) Pilot/Controller Glossary defines in detail, all terms and abbreviations used throughout this publication. Unless otherwise indicated, miles are nautical miles (NM), altitudes indicate feet above Mean Sea Level (MSL), and times used are Coordinated Universal Time (UTC).

The Notices to Airmen Publication (NOTAM) includes current Flight Data Center (FDC) NOTAMs. NOTAMs alert pilots of new regulatory requirements and reflect changes to Standard Instrument Approach Procedures (SIAPs), flight restrictions, and aeronautical chart revisions. This publication is prepared every 28 days by the FAA, and is available by subscription from the Government Printing Office.

In addition to NOTAMs, the Airport/Facility Directory (A/FD) and the Special Notices page of the Aeronautical Information Services website are also useful to pilots.

KEEP YOUR CHARTS CURRENT

Aeronautical information changes rapidly, so it is important that pilots check the effective dates on each aeronautical chart and publication. To avoid danger, it is important to always use current editions and discard obsolete charts and publications.

To confirm that a chart or publication is current, refer to the next scheduled edition date printed on the cover. Pilots should also check Aeronautical Chart Bulletins in the A/FD, the Aeronautical Information Services website (aeronav.faa.gov) and NOTAMs for important updates between chart and publication cycles that are essential for safe flight.

All information in this guide is effective through September 2013. All graphics used in this guide are for educational purposes. Please do not use them for flight navigation.

REPORTING CHART DISCREPANCIES

Your experience as a pilot is valuable and your feedback is important. We make every effort to display accurate information on all FAA charts and publications, so we appreciate your input. Please notify us concerning any requests for changes, or potential discrepancies you see while using our charts and related products.

**FAA, Aeronautical Information Services
Customer Operations Team
1305 East-West Highway
SSMC-4, Suite 4400
Silver Spring, MD 20910-3281**

**Telephone Toll-Free 1-800-638-8972
E-mail: 9-AMC-Aerochart@faa.gov**





VFR AERONAUTICAL CHARTS

EXPLANATION OF VFR TERMS AND SYMBOLS

This chapter covers the Sectional Aeronautical Chart (Sectional). These charts include the most current data at a scale of (1:500,000) which is large enough to be read easily by pilots flying by sight under Visual Flight Rules. Sectionals are named after a major city within its area of coverage.

The chart legend includes aeronautical symbols and information about drainage, terrain, the contour of the land, and elevation. You can learn to identify aeronautical, topographical, and obstruction symbols (such as radio and television towers) by using the legend.

A brief description next to a small black square indicates the exact location for many of the landmarks easily recognized from the air, such as stadiums, pumping stations, refineries, etc. A small open circle indicates an Oil Well. Small black circles with a label show the location of water, oil and gas tanks. The scale for some items may be increased to make them easier to read on the chart.

AeroNav Products' charts are prepared in accordance with specifications of the Interagency Air Cartographic Committee (IACC) and are approved by representatives of the Federal Aviation Administration (FAA) and the Department of Defense (DoD).

WATER FEATURES (HYDROGRAPHY)

Water features are depicted using two tones of blue, and are considered either "Open Water" or "Inland Water." "Open Water," a lighter blue tone, shows the shoreline limitations of all coastal water features at the average (mean) high water levels for oceans and seas. Light blue also represents the connecting waters like bays, gulfs, sounds, fjords, and large estuaries.

Exceptionally large lakes like the Great Lakes, Great Salt Lake, and Lake Okeechobee, etc., are considered Open Water features. The Open Water tone extends inland as far as necessary to adjoin the darker blue "Inland Water" tones. All other bodies of water are marked as "Inland Water" in the darker blue tone.

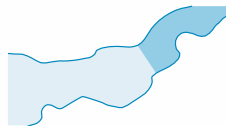

LAND FEATURES (TERRAIN) AND OBSTRUCTIONS

The elevation and configuration of the Earth's surface is important to pilots. Our Aeronautical Information Specialists are devoted to showing the contour of the earth and any obstructions clearly and accurately on our charts. We use five different techniques: contour lines, shaded relief, color tints, obstruction symbols, and Maximum Elevation Figures (MEF).

1. Contour lines join points of equal elevation. On Sectionals, basic contours



are spaced at 500' intervals. Intermediate contours are typically at 250' intervals in moderately level or gently rolling areas. Auxiliary contours at 50', 100', 125', or 150' intervals occasionally show smaller relief features in areas of relatively low relief. The pattern of these lines and their spacing gives the pilot a visual concept of the terrain. Widely spaced contours represent gentle slopes, while closely spaced contours represent steep slopes.



2. Shaded relief shows how terrain may appear from the air. Shadows are shown as if light is coming from the northwest, because studies show that our visual perception has been conditioned to this view.
3. Different color tints show bands of elevation relative to sea level. These colors range from light green for the lower elevations, to dark brown for the higher elevations.
4. Obstruction symbols show man made vertical features that could affect safe navigation. FAA's Aeronautical Information Management (AIM) maintains a database of over 1,200,000 obstacles in the United States, Canada, the Caribbean, Mexico and U.S. Pacific Island Territories. Aeronautical Specialists evaluate each obstacle based on charting specifications before adding it to a visual chart. When a Specialist is not able to verify the position or elevation of an obstacle, it is marked UC, meaning it is "under construction" or being reported, but has not been verified.

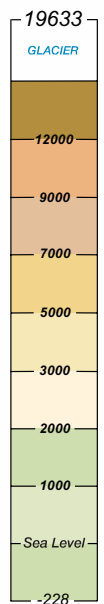

The FAA uses a Digital Obstacle File (DOF) to collect and disseminate data. Because land and obstructions frequently change, the source data on obstructions and terrain is occasionally incomplete or not accurate enough for use in aeronautical publications. For example, when the FAA receives notification about an obstruction, and there is insufficient detail to determine its position and elevation, the FAA Flight Edit Program conducts an investigation.

The Flight Edit crew visually verifies the cultural, topographic, and obstacle data. Charts are generally flight-checked every four years. This review includes checking for any obstruction that has been recently built, altered, or dismantled without proper notification.

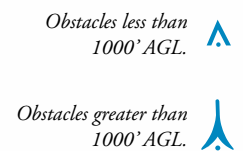

Sectional Charts and Terminal Area Charts (TACs) typically show manmade obstacles extending more than 200' Above

Ground Level (AGL), unless they appear in yellow city tint. Features considered to be hazardous obstacles to low-level flight are; smokestacks, tanks, factories, lookout towers, and antennas, etc. On World Aeronautical Charts (WACs) only those obstacles at 500' AGL and higher are charted.

Manmade features used by FAA Air Traffic Control as checkpoints use a graphic symbol shown in black with the required elevation data in blue. The elevation of the top of the obstacle above Mean Sea Level (MSL) and the height of the structure (AGL) is also indicated (when known or can be reliably determined by a Specialist). The AGL height is in parentheses below the MSL elevation. In extremely congested areas, the FAA typically omits the AGL values to avoid confusion.

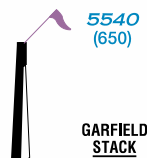

Whenever possible, the FAA depicts specific obstacles on charts. However, in high-density areas like city complexes, only the highest obstacle is represented on the chart using the group obstacle symbol to maximize legibility.



Obstacles under construction are indicated by placing the letters UC next to the obstacle type.

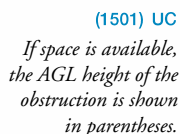

Obstacles with high-intensity strobe lighting systems may operate part-time or by proximity activation and are shown as follows:

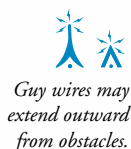

5. The Maximum Elevation Figure (MEF) represents the highest elevation within a quadrant, including terrain and other vertical obstacles (towers, trees, etc.). A quadrant on Sectionals is the area bounded by ticked lines dividing each 30 minutes of latitude and each 30 minutes of longitude. MEF figures are rounded up to the nearest 100' value and the last two digits of the number are not shown.

MEFs over land and open water areas are used in areas containing manmade obstacles such as oil rigs.

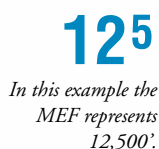

In the determination of MEFs, the FAA uses extreme care to calculate the values based on the existing elevation data shown on source material. Aeronautical Information Specialists use the following procedure to calculate MEFs:

When a manmade obstacle is more than 200' above the highest terrain within the quadrant:

1. Determine the elevation of the top of the obstacle above MSL.
2. Add the possible vertical error of the source material to the above figure (100' or 1/2 contour interval when interval on source exceeds 200'. U.S. Geological Survey Quadrangle Maps with contour intervals as small as 10' are normally used).
3. Round the resultant figure up to the next higher hundred-foot level.

Example:

Elevation of obstacle top (MSL) =	2424
Possible vertical error	+100
	equals 2524
Raise to the following 100' level	2600
Maximum Elevation Figure	26

When a natural terrain feature or natural vertical obstacle (e.g. a tree) is the highest feature within the quadrangle:

1. Determine the elevation of the feature.
2. Add the possible vertical error of the source to the above figure (100' or 1/2 the contour interval when interval on source exceeds 200').
3. Add a 200' allowance for uncharted natural or manmade obstacles. Chart specifications don't require the portrayal of obstacles below minimum height.
4. Round the figure up to the next higher hundred-foot level.

Example:

Elevation of obstacle top (MSL) =	3450
Possible vertical error	+100
Obstacle Allowance	+200
	equals 3750
Raise to the following 100' level	3800
Maximum Elevation Figure	38

Pilots should be aware that while the MEF is based on the best information available to the Specialist, the figures are not verified by field surveys. Also, users should consult the Aeronautical Chart Bulletin in the A/FD or AeroNav Products website to ensure that your chart has the latest MEF data available.





RADIO AIDS TO NAVIGATION

On VFR Charts, information about radio aids to navigation (NAVAID) is boxed, as illustrated. Duplication of data is avoided. When two or more radio aids in a general area have the same name with different frequencies, Tactical Air Navigation (TACAN) channel numbers, or identification letters, and no misinterpretation can result, the name of the radio aid may be indicated only once within the identification box. Very High Frequency/Ultra High Frequency (VHF/UHF) Navigation Aid (NAVAID) names and identification boxes (shown in blue) take precedence. Only those items that differ (e.g., frequency, Morse Code) are repeated in the box in the appropriate color. The choice of separate or combined boxes is made in each case on the basis of economy of space and clear identification of the radio aids.

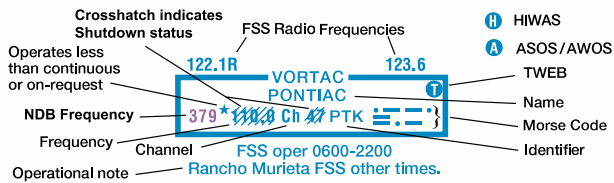

A NAVAID that is physically located on an airport may not always be represented as a typical NAVAID symbol. A small open circle indicates the NAVAID location when collocated with an airport icon. The type of NAVAID will be identified by: "VOR," (VHF Omni-Directional Range) "VORTAC" (VOR Tactical Aircraft Control) or "VOR-DME," (VOR-Distance Measuring Equipment) positioned on and breaking the top line of the NAVAID box.

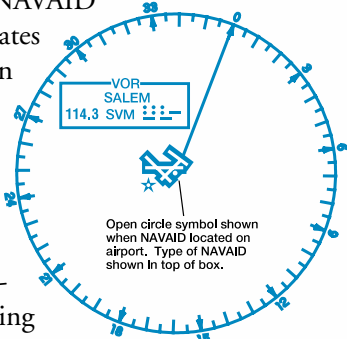

AIRPORTS

Airports in the following categories are charted as indicated (additional symbols are shown later in this Section).

Public use airports:

- Hard-surfaced runways greater than 8069' or some multiple runways less than 8069'
- Hard-surfaced runways 1500' to 8069'
- Other than hard-surfaced runways
- Seaplane bases

Military airports:

- Other than hard-surfaced runways

Hard-surfaced U.S. military runways are depicted like public-use airports. They are identified by abbreviations such as: AAF (Army Air Field), AFB (Air Force Base), MCAS (Marine Corps Air Station), NAS (Naval Air Station), NAF (Naval Air Facility), NAAS (Naval Auxiliary Air Station), etc.

Canadian military airports are identified by the abbreviation DND (Department of National Defense).

Services available:

Tick marks around the basic airport symbol indicate that fuel is available and the airport is tended during normal working hours (Monday through Friday 10:00 A.M. to 4:00 P.M. local time).

Other airports with or without services:



Airports are plotted in their true geographic position unless the symbol conflicts with a NAVAID at the same location. In such cases, the airport symbol will be displaced, but the relationship between the airport and the NAVAID will be retained.

Airports are identified by their designated name. Generic parts of long airport names (such as "airport," "field," or "municipal") and the first names of persons are commonly omitted unless they are needed to distinguish one airport from another with a similar name.

The figure at right illustrates the coded data that is provided along with the airport name.

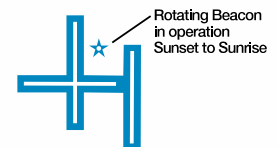



FSS
NO SVFR
NAME (NAM) (PNAM)
CT - 118.3 * C
ASOS/AWOS 135.42
897 L 110 122.95 — UNICOM
RP 23, 34
VFR Advsy 125.0
WX CAM
AOE

The elevation of an airport is the highest point on the usable portion of the landing areas. Runway length is the length of the longest active runway, including displaced thresholds and excluding overruns. Runway length is shown to the nearest 100', using 70 as the rounding point; a runway 8070' in length is charted as 81, while a runway 8069' in length is charted as 80. If a seaplane base is collocated with an airport, there will be additional seaplane base water information listed for the elevation, lighting and runway.



CONTROLLED AIRSPACE

Controlled airspace consists of those areas where some or all aircraft may be subject to air traffic control, such as: Class A, Class B, Class C, Class D, Class E Surface (SFC) and Class E Airspace.

- FSS** - Flight Service Station on field
- NO SVFR** - Airports where fixed wing special visual flight rules operations are prohibited (shown above airport name) F.A.R. 91
-  - Indicates F.A.R. 93 Special Air Traffic Rules and Airport Traffic Patterns
- (NAM)** - Location Identifier
- (PNAM)** - ICAO Location Indicator
- CT - 118.3** - Control Tower (CT) - primary frequency
 - ★ - Star indicates operation part-time. See tower frequencies tabulation for hours of operation
 -  - Follows the Common Traffic Advisory Frequency (CTAF) (Not shown on WAC)
- ATIS 123.8** - Automatic Terminal Information Service
- AFIS 135.2** - Automatic Flight Information Service
- ASOS/AWOS 135.42** - Automated Surface Weather Observing Systems; shown when full-time ATIS is not available. (Not shown on WAC) Some ASOS/AWOS facilities may not be located at airport.
- 897** - Elevation in feet
 - L** - Lighting in operation Sunset to Sunrise
 - ***L** - Lighting limitations exist; refer to Airport/Facility Directory.
- 110** - Length of longest runway in hundreds of feet; usable length may be less.
- UNICOM** - Aeronautical advisory station ("U" only on WAC)
- RP 23, 34** - Runways with Right Traffic Patterns (public use) (Not shown on WAC)
- RP*** - (See Airport/Facility Directory)
- VFR Advsy 125.0** - VFR Advisory Service shown where ATIS is not available and frequency is other than primary CT frequency.
- WX CAM** - Weather Camera (AK)
- AOE** - Airport of Entry

Airports with Control Towers (CT) and their related data are shown in blue. All other airports and their related data are shown in magenta. The **L** symbol indicates that runway lights are on from dusk to dawn. A ***L** indicates that the pilot must consult the Airport/Facility Directory (A/FD) to determine runway lighting limitations, such as: available on request (by radio-call, letter, phone, etc), part-time lighting, or pilot/airport controlled lighting. Lighting codes refer to runway edge lights. The lighted runway may not be the longest runway available, and lights may not be illuminated along the full length of the runway. The A/FD has a detailed description of airport and air navigation lighting aids for each airport. A dash represents no runway edge lights.

The symbol ★ indicates the existence of a rotating or flashing airport beacon operating from dusk to dawn. The Aeronautical Information Manual (AIM) thoroughly explains the types and uses of airport lighting aids.

Right traffic information is shown using the abbreviation 'RP' for right pattern, followed by the appropriate runway number(s) (RP 18). Special conditions or restrictions to the right pattern are indicated by the use of an asterisk (RP*) to direct the pilot to the Airport/Facility Directory for special instructions and/or restrictions.

An airport with an objectionable airspace will be labeled as such, "OBJECTIONABLE." This airport may adversely affect airspace use. FAA Airports Offices are responsible for airspace determinations and follow FAA Order 7400.2. If an airport owner or chart user wishes to challenge the objectionable status, he or she should contact their FAA Regional Airports Office.

Class A Airspace within the United States extends from 18,000' up to 60,000' MSL. While visual charts do not depict Class A, it is important to note its existence.

Class B Airspace is shown in abbreviated form on the World Aeronautical Chart (WAC). The Sectional Aeronautical Chart (Sectional) and Terminal Area Chart (TAC) show Class B in greater detail. The MSL ceiling and floor altitudes of each sector are shown in solid blue figures with the last two zeros omitted. Floors extending "upward from above" a certain altitude are preceded by a (+). Operations at and below these altitudes are outside of Class B Airspace. Radials and arcs used to define Class B are prominently shown on TACs. Detailed rules and requirements associated with the particular Class B are shown. The name by which the Class B is identified is shown as **LAS VEGAS CLASS B** for example.

Class B MSL **90**
Altitudes **20**

Class C Airspace is shown in abbreviated form on WACs. Sectionals and TACs show Class C in greater detail.

The MSL ceiling and floor altitudes of each sector are shown in solid magenta figures with the last two zeros eliminated.

Class C MSL **70**
Altitudes **15**

The figure at right identifies a sector that extends from the surface to the base of the Class B.

T
SFC

Class C airspace is identified by name: **BURBANK CLASS C**.

Separate notes, enclosed in magenta boxes, give the approach control frequencies to be used by arriving VFR aircraft to establish two-way radio communication before entering the Class C (generally within 20 NM):

CTC BURBANK APP WITHIN
20 NM ON 124.6 395.9

Class D Airspace is identified with a blue dashed line. Class D operating less than continuous is indicated by the following

note: [See NOTAMs/Directory for Class D eff hrs](#)

Ceilings of Class D are shown as follows: **30**.

A minus in front of the figure is used to indicate "from surface to, but not including..."

Class E Surface (SFC) Airspace is symbolized with a magenta dashed line. Class E (SFC) operating less than continuous is indicated by the following note:

[See NOTAMs/Directory for Class E \(sfc\) eff hrs](#)





Class E Airspace exists at 1200' AGL unless designated otherwise. The lateral and vertical limits of all Class E, (up to, but not including 18,000') are shown by narrow bands of vignette on Sectionals and TACs.

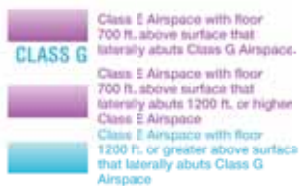

Controlled airspace floors of 700' above the ground are defined by a magenta vignette; floors other than 700' that laterally abuts uncontrolled airspace (Class G) are defined by a blue vignette; differing floors greater than 700' above the ground are annotated by a symbol and a number **2400 AGL** **4500 MSL** indicating the floor.

If the ceiling is less than 18,000' MSL, the value (preceded by the word "ceiling") is shown along the limits of the controlled airspace. These limits are shown with the same symbol indicated above.

UNCONTROLLED AIRSPACE

Class G Airspace within the United States extends up to 14,500' Mean Sea Level. At and above this altitude is Class E, excluding the airspace less than 1500' above the terrain and certain special use airspace areas.

SPECIAL USE AIRSPACE

Special Use Airspace (SUA) confines certain flight activities and restricts entry, or cautions other aircraft operating within specific boundaries. Except for Controlled Firing Areas, SUA areas are depicted on VFR Charts. Controlled Firing Areas are not charted because their activities are suspended immediately when spotter aircraft, radar, or ground lookout positions indicate an aircraft might be approaching the area. Nonparticipating aircraft are not required to change their flight paths. SUA areas are shown in their entirety (within the limits of the chart), even when they overlap, adjoin, or when an area is designated within another area. The areas are identified by type and identifying name/number, and are positioned either within or immediately adjacent to the area.

PROHIBITED, RESTRICTED or WARNING AREA

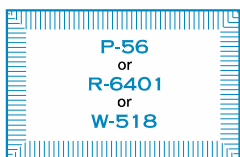

ALERT AREA



MILITARY OPERATIONS AREA (MOA)



OTHER AIRSPACE AREAS

Mode C Required Airspace (from the surface to 10,000' MSL) within 30 NM radius of the primary airport(s) for which a Class B is designated, is depicted by a solid magenta line. **MODE C** 30 NM

Mode C is required, but not depicted for operations within and above all Class C up to 10,000' MSL. Enroute Mode C requirements (at and above 10,000' MSL except in airspace at and below 2500' AGL) are not depicted. See FAR 91.215 and the AIM.

FAR 93 Airports and heliports under Federal Aviation Regulation 93 (FAR 93), (Special Air Traffic Rules and Airport Traffic Patterns), are shown by "boxing" the airport name.



TRUCKEE - TAHOE

FAR 91 Airports where fixed wing special visual flight rules operations are prohibited (FAR 91) are shown with the type "NO SVFR" above the airport name.

National Security Areas indicated with a broken magenta line and **Special Flight Rules Areas (SFRAs)** indicated with the following symbol: consist of airspace with defined vertical and lateral dimensions established at locations where there is a requirement for increased security and safety of ground facilities. Pilots should avoid flying through these depicted areas. When necessary, flight may be temporarily prohibited.

The Washington DC Flight Restricted Zone (FRZ) is related to National Security. It is depicted using the Prohibited/Restricted/Warning Area symbology and is located within the SFRA. It is defined as the airspace within approximately a 13 to 15 NM radius of the DCA VOR-DME. Additional requirements are levied upon aviators requesting access to operate inside the National Capital Region.

Temporary Flight Restriction (TFR) Areas Relating to National Security are indicated with a broken blue line A Temporary Flight Restriction (TFR) is a type of Notice to Airmen (NOTAM). A TFR defines an area where air travel is restricted due to a hazardous condition, a special event, or a general warning for the entire airspace. The text of the actual TFR contains the fine points of the restriction. It is important to note that only TFRs relating to National Security are charted.

Air Defense Identification Zones (ADIZs) are symbolized using the ADIZ symbol: As defined in Code of Federal Regulations 14 (CFR 14) Part 99, an ADIZ is an area in which the ready identification, location, and control of all aircraft is required in the interest of national security. ADIZ boundaries include Alaska, Canada and the Contiguous U.S.

Terminal Radar Service Areas (TRSAs) are shown in their entirety, symbolized by a screened black outline of the entire area including the various sectors within the area

The outer limit of the entire TRSA is a continuous screened black line. The various sectors within the TRSA are symbolized by narrower screened black lines.

Each sector altitude is identified in solid black color by the MSL ceiling and floor values of the respective sector, eliminating the last two zeros. A leader line is used when the altitude values must be positioned outside the respective sectors because of charting space limitations. The TRSA name is shown near the north position of the TRSA as follows: **PALM SPRINGS TRSA**. Associated frequencies are listed in a table on the chart border.

Military Training Routes (MTRs) are shown on Sectionals and TACs. They are identified by the route designator: . Route designators are shown in solid black on the route centerline, positioned along the route for continuity. The designator IR or VR is not repeated when two or more routes are established over the same airspace, e.g., IR201-205-227. Routes numbered 001 to 099 are shown as IR1 or VR99, eliminating the initial zeros. Direction of flight along the route is indicated by small arrowheads adjacent to and in conjunction with each route designator.

The following note appears on Sectionals and TACs covering the conterminous United States.

MILITARY TRAINING ROUTES (MTRs)

All IR and VR MTRs are shown, and may extend from the surface upwards. Only the route centerline, direction of flight along the route and the route designator are depicted - route widths and altitudes are not shown.

Since these routes are subject to change every 56 days, and the charts are reissued every 6 months, you are cautioned and advised to contact Flight Service for route dimensions and current status for those routes affecting your flight.

Routes with a change in the alignment of the charted route centerline will be indicated in the Aeronautical Chart Bulletin of the Airport/Facility Directory.

DoD users refer to Area Planning AP/1B Military Training Routes North and South America for current routes.

There are IFR (IR) and VFR (VR) routes as follows: Route identification:

- a. Routes at or below 1500' AGL (with no segment above 1500') are identified by four-digit numbers; e.g., VR1007, etc. These routes are generally developed for flight under Visual Flight Rules.
- b. Routes above 1500' AGL (some segments of these routes may be below 1500') are identified by three or fewer digit numbers; e.g., IR21, VR302, etc. These routes are developed for flight under Instrument Flight Rules.

MTRs can vary in width from 4 to 16 miles. Detailed route width information is available in the Flight Information Publication (FLIP) AP/1B (a Department of Defense publication), or through the 56 Day NASR Subscription from the National Flight Data Center (NFDC).

Special Military Activity areas are indicated on Sectionals by a boxed note in black type. The note contains radio frequency information for obtaining area activity status.

SPECIAL MILITARY ACTIVITY
CTC MOBILE RADIO
ON 123.6
FOR ACTIVITY STATUS

TERMINAL AREA CHART (TAC) COVERAGE

TAC coverage is shown on appropriate Sectionals by a 1/4" masked line as indicated below.

Within this area pilots should use TACs, which provide greater detail. A note indicating that the area is on the TAC appears near the masked boundary line.

LOS ANGELES TERMINAL AREA

Pilots are encouraged to use the Los Angeles VFR Terminal Area Chart for flights at or below 10,000'



INSET COVERAGE

Inset coverage is shown on appropriate Sectionals by a 1/8" masked line as indicated below. A note to this effect appears near the masked boundary line.

If inset chart is on the same chart as outline:

INDIANAPOLIS INSET
See inset chart for additional detail

If inset chart is on a different chart:

INDIANAPOLIS INSET
See inset chart on the St. Louis Sectional for additional information

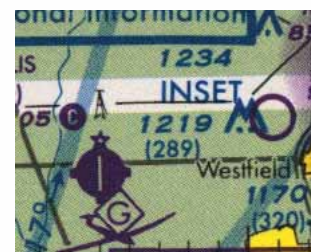



CHART TABULATIONS

Airport Tower Communications are provided in a columnized tabulation for all tower-controlled airports that appear on the respective chart. Airport names are listed alphabetically. If the airport is military, the type of airfield, e.g., AAF, AFB, NAS, is shown after the airfield name. In addition to the airport name, tower operating hours, primary Very High Frequency/Ultra High Frequency (VHF/UHF) local Control Tower (CT), Ground Control (GND CON), and Automatic Terminal Information Service (ATIS) frequencies, when available, will be given. An asterisk (*) indicates that the part-time tower frequency is remotored to a collocated full-time Flight Service Station (FSS) for use as Airport Advisory Service (AAS) when the tower is closed. Airport Surveillance Radar (ASR) and/or Precision Approach Radar (PAR) procedures are listed when available.

Approach Control Communications are provided in a columnized tabulation listing Class B, Class C, Terminal Radar Service Areas (TRSA) and Selected Approach Control Facilities when available. Primary VHF/UHF frequencies are provided for each facility. Sectorization occurs when more than one frequency exists and/or is approach direction dependent. Availability of service hours is also provided.

Special Use Airspace (SUA): Prohibited, Restricted and Warning Areas are presented in blue and listed numerically for U.S. and other countries. Restricted, Danger and Advisory Areas outside the U.S. are tabulated separately in blue. A tabulation of Alert Areas (listed numerically) and Military Operations Areas (MOA) (listed alphabetically) appear on the chart in magenta. All are supplemented with altitude, time of use and the controlling agency/contact facility, and its frequency when available. The controlling agency will be shown when the contact facility and frequency data is unavailable.





Airports with control towers are indicated on the face of the chart by the letters CT followed by the primary VHF local control frequency (ies). Information for each tower is listed in the table below. Operational hours are local time. The primary VHF and UHF local control frequencies are listed. An asterisk (*) indicates the part-time tower frequency is remoted to a collocated full-time FSS for use as Airport Advisory Service (AAS) during hours the tower is closed. The primary VHF and UHF ground control frequencies are listed.

Automatic Terminal Information Service (ATIS) frequencies shown on the face of the chart are primary arrival VHF/UHF frequencies. All ATIS frequencies are listed in the table below. ATIS operational hours may differ from tower operational hours.

ASR and/or PAR indicate Radar Instrument Approach available.

"MON-FRI" indicates Monday through Friday.

O/T indicates other times.

Frequencies (VHF/UHF)

Table with columns: CONTROL TOWER, OPERATES, TWR FREQ, GND CON, ATIS, ASR/PAR. Includes airports like AIRBORNE, BLUE GRASS, BOLTON, CHARLOTTESVILLE-ALBEMARLE, CINCINNATI/NORTHERN KENTUCKY INTL, COX DAYTON INTL, EASTERN WV RGNL/SHEPHERD.

Frequencies (VHF/UHF)

CLASS B, CLASS C, TRSA AND SELECTED APPROACH CONTROL FREQUENCIES

Table with columns: FACILITY, FREQUENCIES, SERVICE AVAILABILITY. Includes facilities like CINCINNATI CLASS B, CHARLESTON CLASS C, COLUMBUS CLASS C, DAYTON CLASS C, BRISTOL TRSA, HUNTINGTON TRSA, PERKINSON/BAAF.

SPECIAL USE AIRSPACE ON SECTIONAL CHART

Unless otherwise noted altitudes are MSL and in feet. Time is local. "TO" an altitude means "to and including." FL - Flight Level NO A/G - No aircraft ground communications. Contact Flight Service for information.

† Other times by NOTAM. NOTAM - Use of this term in Restricted Areas indicates FAA and DoD NOTAM systems. Use of this term in all other Special Use areas indicates the DoD NOTAM system.

U.S. P-PROHIBITED, R-RESTRICTED, W-WARNING, A-ALERT, MOA-MILITARY OPERATIONS AREA

Table with columns: NUMBER, ALTITUDE, TIME OF USE, CONTROLLING AGENCY/CONTACT FACILITY, FREQUENCIES. Includes R-6602 A, B, C and A-220.

Table with columns: MOA NAME, ALTITUDE*, TIME OF USE†, CONTROLLING AGENCY/CONTACT FACILITY, FREQUENCIES. Includes BRUSH CREEK, BUCKEYE, EVERS.

*Altitudes indicate floor of MOA. All MOAs extend to but do not include FL 180 unless otherwise indicated in tabulation or on chart. †Other times by DoD NOTAM.

Sunrise to Sunset

CANADA R-RESTRICTED, D-DANGER AND A-ADVISORY AREA

Table with columns: NUMBER, LOCATION, ALTITUDE, TIME OF USE, CONTROLLING AGENCY. Includes restricted areas like CYR754, CYD734, CYA702 (P), CYA752 (M).

A-Acrobatc F-Aircraft Test Area H-Hang Gliding M-Military Operations P-Parachuting S-Soaring T-Training





VFR AERONAUTICAL CHART SYMBOLS

AERONAUTICAL INFORMATION	
AIRPORTS	15
RADIO AIDS TO NAVIGATION	17
AIRSPACE INFORMATION	19
NAVIGATIONAL AND PROCEDURAL INFORMATION	25
CHART LIMITS	27
TOPOGRAPHIC INFORMATION	
CULTURE	
RAILROADS	28
ROADS	28
POPULATED PLACES	29
BOUNDARIES	29
MISCELLANEOUS CULTURAL FEATURES	30
HYDROGRAPHY	
SHORELINES	31
LAKES	31
RESERVOIRS	31
STREAMS	31
MISCELLANEOUS HYDROGRAPHIC FEATURES	32
RELIEF	
CONTOURS	35
ELEVATIONS	35
UNRELIABLE RELIEF	35
SHADED RELIEF	36
AREA RELIEF FEATURES	36
MISCELLANEOUS RELIEF FEATURES	36

GENERAL INFORMATION

Symbols shown are for World Aeronautical Charts (WACs), Sectional Aeronautical Charts (Sectionals), Terminal Area Charts (TACs), VFR Flyway Planning Charts and Helicopter Route Charts. When a symbol is different on any VFR chart series, it will be annotated, e.g., “WAC” or “Not shown on WAC.”





VFR AERONAUTICAL CHARTS - AERONAUTICAL INFORMATION

AIRPORTS

LANDPLANE: CIVIL

Airports having control towers (CT) are shown in blue, all others are shown in magenta.



All recognizable runways, including some which may be closed, are shown for visual identification purposes. Refueling and repair facilities for normal traffic.



Runway patterns will be depicted at airports with at least one hard surfaced runway 1500' or greater in length.



WAC

SEAPLANE: CIVIL



WAC

LANDPLANE: CIVIL-MILITARY

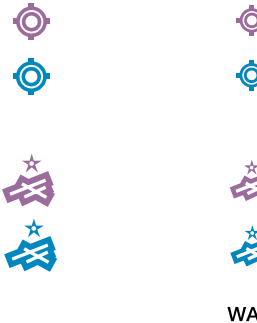

WAC

LANDPLANE: MILITARY

Refueling and repair facilities not indicated.



WAC

AIRPORTS

LANDPLANE: EMERGENCY

No facilities,

or

Complete information is not available.

Add appropriate note as required for hard surfaced runways only: "(CLOSED)"

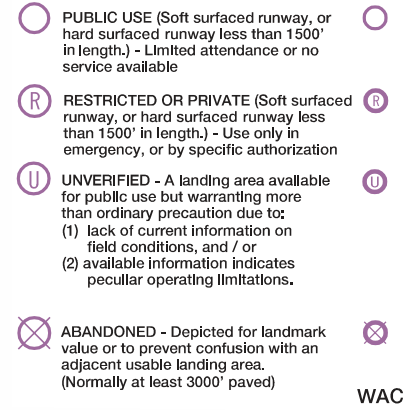

WAC

SEAPLANE: EMERGENCY

No facilities, or complete information is not available.



WAC

HELIPORT (Selected)



WAC

ULTRALIGHT FLIGHT PARK (Selected)



Not shown on WAC





VFR AERONAUTICAL CHARTS - AERONAUTICAL INFORMATION

AIRPORTS

AIRPORT DATA

GROUPING

(Pvt): Non-public use having emergency or landmark value.

*“OBJECTIONABLE”:
This airport may adversely affect airspace use.*

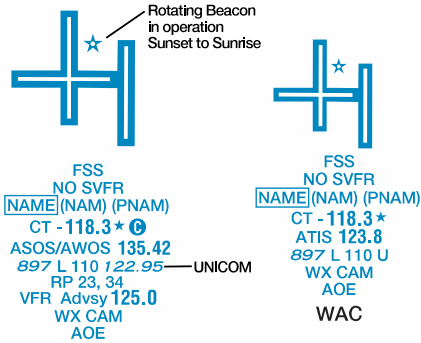

- FSS - Flight Service Station on field
- NO SVFR - Airports where fixed wing special visual flight rules operations are prohibited (shown above airport name) F.A.R. 91
- [] - Indicates F.A.R. 93 Special Air Traffic Rules and Airport Traffic Patterns
- (NAM) - Location Identifier
- (PNAM) - ICAO Location Indicator
- CT - 118.3 - Control Tower (CT) - primary frequency
- ★ - Star indicates operation part-time. See tower frequencies tabulation for hours of operation
- C - Follows the Common Traffic Advisory Frequency (CTAF) (Not shown on WAC)
- ATIS 123.8 - Automatic Terminal Information Service
- AFIS 135.2 - Automatic Flight Information Service
- ASOS/AWOS 135.42 - Automated Surface Weather Observing Systems; shown when full-time ATIS is not available. (Not shown on WAC) Some ASOS/AWOS facilities may not be located at airport.
- 897 - Elevation in feet
- L - Lighting in operation Sunset to Sunrise
- *L - Lighting limitations exist; refer to Airport/Facility Directory.
- 110 - Length of longest runway in hundreds of feet; usable length may be less.
- UNICOM - Aeronautical advisory station ("U" only on WAC)
- RP 23, 34 - Runways with Right Traffic Patterns (public use) (Not shown on WAC)
- RP* - (See Airport/Facility Directory)
- VFR Advsy 125.0 - VFR Advisory Service shown where ATIS is not available and frequency is other than primary CT frequency.
- WX CAM - Weather Camera (AK)
- AOE - Airport of Entry

When information is lacking, the respective character is replaced by a dash. Lighting codes refer to runway edge lights and may not represent the longest runway or full length lighting





VFR AERONAUTICAL CHARTS - AERONAUTICAL INFORMATION

RADIO AIDS TO NAVIGATION

VHF OMNI-DIRECTIONAL RADIO (VOR) RANGE

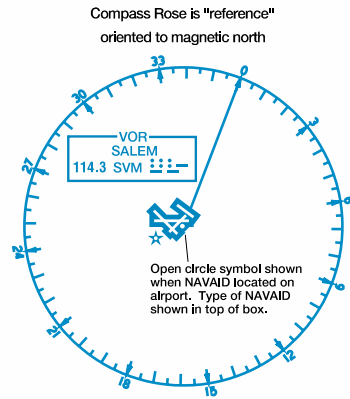

VOR

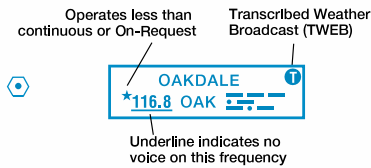

VORTAC

When an NDB NAVAID shares the same name and Morse Code as the VOR NAVAID the frequency can be collocated inside the same box to conserve space.

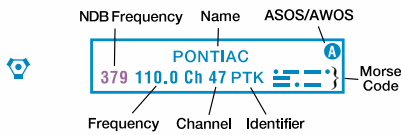

VOR-DME

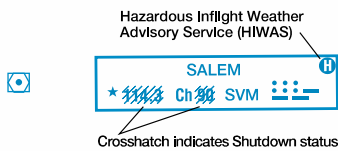

AIR FORCE STATION (AFS)

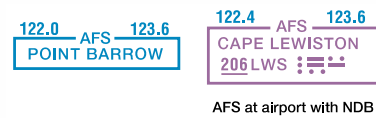

LONG RANGE RADAR STATION (LRRS)

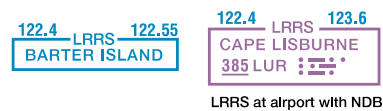

OFF AIRPORT AWOS/ASOS



RADIO AIDS TO NAVIGATION

NON-DIRECTIONAL RADIO BEACON (NDB)

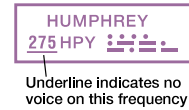

NDB-DME

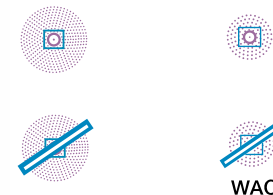

NAVAIDS USED TO DEFINE CLASS B AIRSPACE

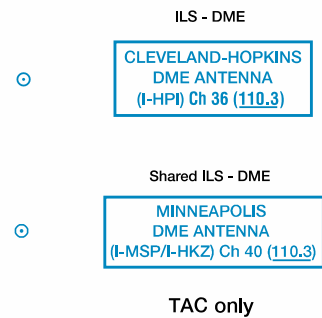

BROADCAST STATIONS (BS)

On request by the proper authority or when a VFR Checkpoint.





VFR AERONAUTICAL CHARTS - AERONAUTICAL INFORMATION

RADIO AIDS TO NAVIGATION

FLIGHT SERVICE STATION (FSS)

Heavy line box indicates Flight Service Station (FSS). Frequencies 121.5, 122.2, 243.0 and 255.4 (Canada - 121.5, 126.7 and 243.0) are available at many FSSs and are not shown above boxes. All other frequencies are shown. Certain FSSs provide Airport Advisory Service, see A/FD. R - Receive only

PONTIAC PTK

No NAVAID of the same name as FSS

or

122.1R

IDAHO FALLS
109.0 Ch 27 IDA

FSS oper 0500-2300
Boise FSS other times.

NAVAID same name as FSS but not an RCO

Transoceanic VHF frequencies are long range four digit numbers. These were used during the World War II era. They now have become legacy frequencies that some Alaska FSSs still maintain by doing radio checks with the U.S. Coast Guard.

2866

PONTIAC PTK

REMOTE COMMUNICATIONS OUTLET (RCO)

Frequencies above thin line box are remotod to NAVAID site. Other FSS frequencies providing voice communication may be available as determined by altitude and terrain. Consult Airport/Facility Directory for complete information.

Thin line box without frequencies and controlling FSS name indicates no FSS frequency available.

123.6

OLYMPIA RCO

McCHORD

122.35

ST PAUL
108.6 STP

MINNEAPOLIS

122.35

HUMPHREY
275 HPY

MILES CITY

FSS radio providing voice communication

ALASKA WEATHER CAMERA

Stand-Alone

ANCHORAGE WX CAM

Collocated with Airport - Must be within 2 NM to have same name.

WRANGELL (68A)
00 - 90 122.6
WX CAM
AOE





VFR AERONAUTICAL CHARTS - AERONAUTICAL INFORMATION

AIRSPACE INFORMATION

CLASS B AIRSPACE

Appropriate notes as required may be shown.

Only the airspace effective below 18,000 feet MSL are shown.

(Mode C see FAR 91.215 /AIM)

All mileages are nautical (NM).

All radials are magnetic.

LAS VEGAS CLASS B

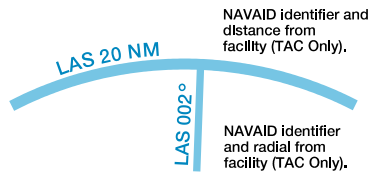

FOR FLIGHTS AT AND BELOW 8000' MSL SEE KANSAS CITY VFR TERMINAL AREA CHART

WAC only

- 80** - Ceiling of Class B in hundreds of feet MSL
- 40** - Floor of Class B in hundreds of feet MSL

(Floors extending "upward from above" a certain altitude are preceded by a +. Operations at and below these altitudes are outside of Class B Airspace.)

CTC LAS VEGAS APP ON 121.1 OR 257.8

TAC only

AIRSPACE INFORMATION

CLASS C AIRSPACE

Appropriate notes as required may be shown.

(Mode C see FAR 91.215 /AIM)

BURBANK CLASS C

See NOTAMS/Directory for Class C eff hrs



BOISE CLASS C

See NOTAMS/Directory for Class C eff hrs



Outer limit only, segments not shown

WAC

FOR FLIGHTS AT OR BELOW 6600 MSL SEE PHOENIX VFR SECTIONAL CHART

WAC only

- 48** - Ceiling of Class C in hundreds of feet MSL
- 30** - Floor of Class C in hundreds of feet MSL

- T** - Ceiling is to but not including floor of Class B
- SFC** - Surface

CTC BURBANK APP WITHIN 20 NM ON 124.6 395.9

Not shown on WAC

CLASS D AIRSPACE

See NOTAMS/Directory for Class D eff hrs

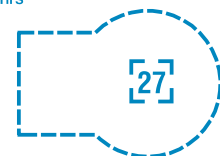

See NOTAMS/Directory for Class D/E (sfc) eff hrs

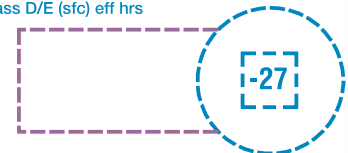

(A minus in front of the figure is used to indicate "from surface to but not including...")

ALTITUDE IN HUNDREDS OF FEET MSL

Not shown on WAC





VFR AERONAUTICAL CHARTS - AERONAUTICAL INFORMATION

AIRSPACE INFORMATION

CLASS E AIRSPACE

The limits of Class E airspace shall be shown by narrow vignettes or by the dashed magenta symbol. Individual units of designated airspace are not necessarily shown; instead, the aggregate lateral and vertical limits shall be defined by the following:

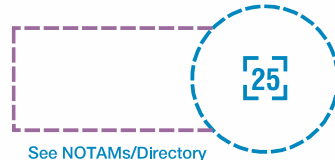

See NOTAMs/Directory for Class D/E (sfc) eff hrs

Airspace beginning at the surface (sfc) designated around airports...



See NOTAMs/Directory for Class E (sfc) eff hrs

Airspace beginning at 700 feet AGL...



See NOTAMs/Directory for 700' Class E eff hrs

Airspace beginning at 700 feet AGL that laterally abuts uncontrolled airspace (Class G)...



Airspace beginning at 1200 feet AGL or greater that laterally abuts uncontrolled airspace (Class G)...



Differentiates floors of airspace greater than 700 feet above the surface...



8000 AGL

11,500 MSL

Not shown on WAC

When the ceiling is less than 18,000 feet MSL, the value, prefixed by the word "ceiling," shall be shown along the limits.

AIRSPACE INFORMATION

OFFSHORE CONTROL AREAS

ATLANTIC LOW CONTROL AREA



Class G Airspace

9500 MSL ATLANTIC LOW CONTROL AREA



8000 MSL CONTROL AREA 1148L

ATLANTIC LOW CONTROL AREA



WAC

ATLANTIC LOW CONTROL AREA CONTROL AREA 1148L

CANADIAN AIRSPACE

Individual units of designated Canadian airspace are not necessarily shown; instead, the aggregate lateral and vertical limits shall be portrayed as closely as possible to the comparable U.S. airspace.



TCA Class B/C/D

TCA Class B/C/D



WAC

Outer limit only, segments not shown

125 - Ceiling of TCA Class B/C/D in hundreds of feet MSL
25 - Floor of TCA Class B/C/D in hundreds of feet MSL



Class D CZ

Class C or D Control Zone

ALTITUDE IN HUNDREDS OF FEET MSL



Class E CZ

Class E Control Zone

Not shown on WAC

Appropriate notes as required may be shown.

AIRSPACE CLASSIFICATION (SEE CANADA FLIGHT SUPPLEMENT) AND OPERATIONAL REQUIREMENTS (DOD USERS, SEE DOD AREA PLANNING AP/1) MAY DIFFER BETWEEN CANADA AND UNITED STATES

NOTE: REFER TO CURRENT CANADIAN CHARTS AND FLIGHT INFORMATION PUBLICATIONS FOR INFORMATION WITHIN CANADIAN AIRSPACE



VFR AERONAUTICAL CHARTS - AERONAUTICAL INFORMATION

AIRSPACE INFORMATION

AIRSPACE

OUTSIDE OF U.S.

Other than Canada

Appropriate notes as required may be shown.

NOTE: DOD USERS, REFER TO CURRENT DOD (NGA) FLIGHT INFORMATION PUBLICATIONS FOR INFORMATION OUTSIDE OF U.S. AIRSPACE

FLIGHT INFORMATION REGIONS (FIR)



OCEANIC CONTROL AREAS (OCA)



CONTROL AREAS (CTA)



LOW ALTITUDE AIRWAYS VOR AND LF/MF (CLASS E AIRSPACE)

Low altitude Federal Airways are indicated by centerline.

Only the controlled airspace effective below 18,000 feet MSL is shown.

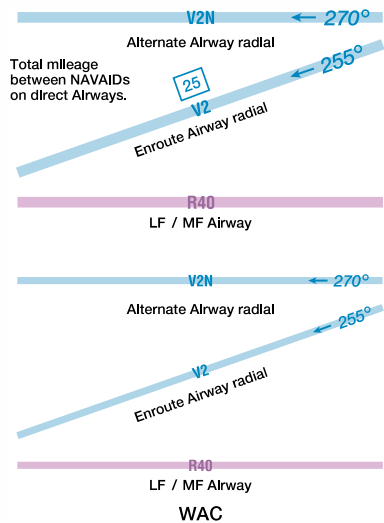

AIRSPACE INFORMATION

MISCELLANEOUS AIR ROUTES

Combined Federal Airway/RNAV "T" Routes are identified in solid blue type adjacent to the solid magenta federal airway identification. The joint route symbol is screened magenta.

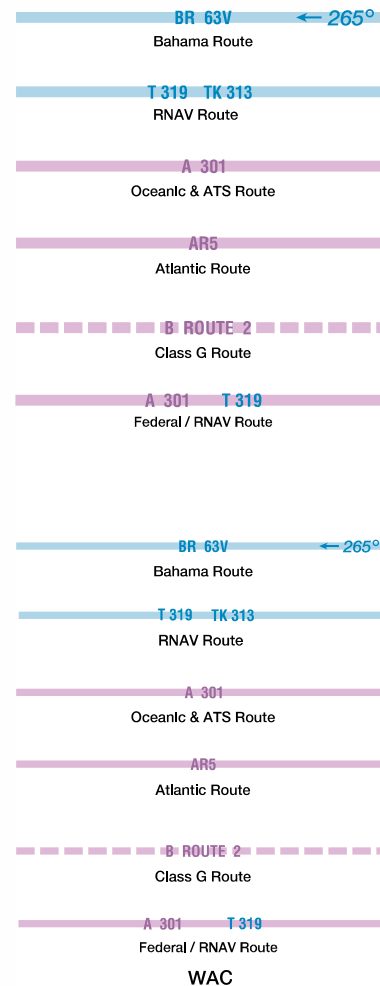



VFR AERONAUTICAL CHARTS - AERONAUTICAL INFORMATION

AIRSPACE INFORMATION

SPECIAL USE AIRSPACE

Only the airspace effective below 18,000 feet MSL is shown.

The type of area shall be spelled out in large areas if space permits.

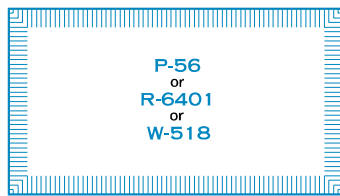

PROHIBITED, RESTRICTED or WARNING AREA



ALERT AREA



MILITARY OPERATIONS AREA (MOA)

MILITARY TRAINING ROUTES (MTR)



Not shown on WAC

SPECIAL MILITARY ACTIVITY ROUTES (SMAR)

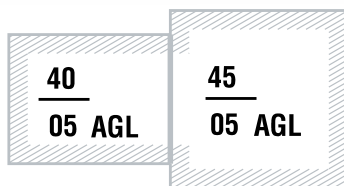

Boxed notes shown adjacent to route.

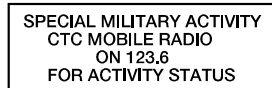

40 --- Ceiling of SMAR in hundreds of feet MSL
05 AGL --- Floor of SMAR in hundreds of feet AGL

Not shown on WAC

AIRSPACE INFORMATION

SPECIAL AIR TRAFFIC RULES / AIRPORT PATTERNS (FAR 93)



Appropriate boxed note as required shown adjacent to area.

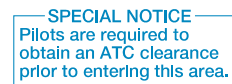

SPACE OPERATIONS AREA (FAR 91.143)

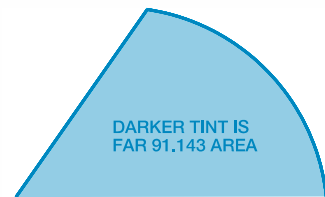

Not shown on WAC

MODE C (FAR 91.215)

Appropriate notes as required may be shown.



MISCELLANEOUS AIRSPACE AREAS

Parachute Jumping Area with Frequency



Glider Operating Area



Ultralight Activity



Hang Glider Activity



Unmanned Aircraft Activity



Not shown on WAC

VFR AERONAUTICAL CHARTS - AERONAUTICAL INFORMATION

AIRSPACE INFORMATION

SPECIAL CONSERVATION AREAS

National Park, Wildlife Refuge, Primitive and Wilderness Areas, etc.

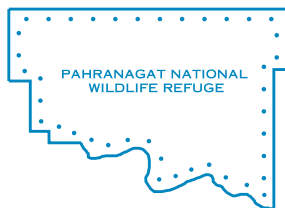

Not shown on WAC

NOAA Regulated National Marine Sanctuary Designated Areas



Flight operations below 1000' AGL over the designated areas within the Gulf of Farallones National Marine Sanctuary violate NOAA regulations (see 15 CFR 922).

SPECIAL AIRSPACE AREAS

SPECIAL FLIGHT RULES AREA (SFRA) RELATING TO NATIONAL SECURITY

Example: Washington DC

Appropriate notes as required may be shown.

Note: Delimiting line not shown when it coincides with International Boundary, projection lines or other linear features.



Washington DC Metropolitan Area Special Flight Rules Area/Flight Restricted Zone restrictions are in effect. Special regulations apply to all aircraft operations from the surface to but not including Flight Level 180 in the Washington DC Metropolitan Area. Pilots should contact a local FSS for NOTAM information prior to flight in the Washington DC Metropolitan Area.

FLIGHT RESTRICTED ZONE (FRZ) RELATING TO NATIONAL SECURITY

Example: Washington DC



AIRSPACE INFORMATION

SPECIAL FLIGHT RULES AREA (SFAR)

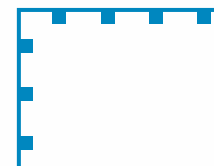

CAUTION
Pilots should not attempt flight in the Grand Canyon Special Flight Rules area (GCN SFRA) below 18,000 feet using this chart as their primary navigational reference. Pilots Intending to fly within the Grand Canyon SFRA should refer to the Grand Canyon VFR Aeronautical Chart for detailed information. Chart is available from the Federal Aviation Administration (phone 1-800-638-8972) or authorized agents.

TEMPORARY FLIGHT RESTRICTION (TFR) RELATING TO NATIONAL SECURITY

Example:



Appropriate notes as required may be shown.

CAUTION
P-40 AND R-4009 EXPANDED BY TEMPORARY FLIGHT RESTRICTION. CONTACT AFSS FOR LATEST STATUS AND NOTAMS

Not shown on WAC

AIR DEFENSE IDENTIFICATION ZONE (ADIZ)

Note. Delimiting line not shown when it coincides with International Boundary, projection lines or other linear features.

CONTIGUOUS U.S. ADIZ



NATIONAL SECURITY AREA

Appropriate notes as required may be shown.



NOTICE
FOR REASONS OF NATIONAL SECURITY PILOTS ARE REQUESTED TO AVOID FLIGHT BELOW 1200' MSL IN THIS AREA

Not shown on WAC





VFR AERONAUTICAL CHARTS - AERONAUTICAL INFORMATION

AIRSPACE INFORMATION

HIGH ENERGY RADIATION AREAS

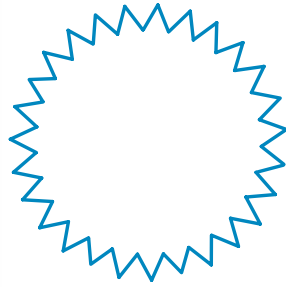

Appropriate notes as required may be shown.

HAZARDOUS LASER TRANSMISSIONS SFC to infinity See Airport Facility/Directory

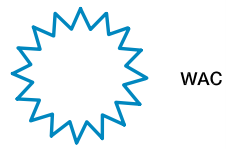

WAC

TERMINAL RADAR SERVICE AREA (TRSA)

PALM SPRINGS TRSA



80 - Ceiling of TRSA in hundreds of feet MSL
40 - Floor of TRSA in hundreds of feet MSL

Appropriate notes as required may be shown.

SEE TWR FREQ TAB

Not shown on WAC

IFR ROUTES

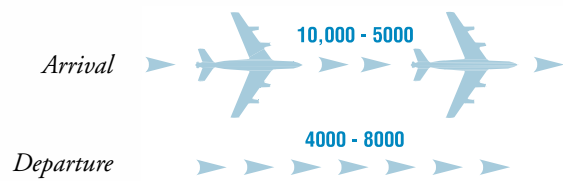

TAC only

VFR TRANSITION ROUTES

Appropriate notes as required may be shown.

VFR TRANSITION ROUTE ATC CLEARANCE REQUIRED SEE SHOWBOAT GRAPHIC ON SIDE PANEL

Uni-directional



Bi-directional



TAC only





VFR AERONAUTICAL CHARTS - AERONAUTICAL INFORMATION

NAVIGATIONAL AND PROCEDURAL INFORMATION

ISOGONIC LINE AND VALUE

Isogonic lines and values shall be based on the five year epoch magnetic variation model.

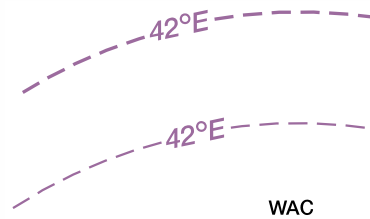

LOCAL MAGNETIC NOTES

Unreliability Notes

Magnetic disturbance of as much as 78° exists at ground level and 10° or more at 3000 feet above ground level in this vicinity.

COMPASS ROSETTE

Shown only in areas void of VOR roses.

Compass rosette will be based on the five year epoch magnetic variation model.

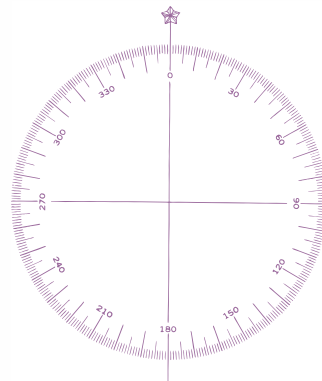

NAVIGATIONAL AND PROCEDURAL INFORMATION

AERONAUTICAL LIGHTS

By Request

Rotating Light with Flashing Code Identification Light

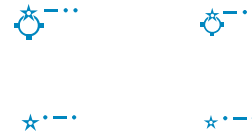

Rotating Light with Course Lights and Site Number

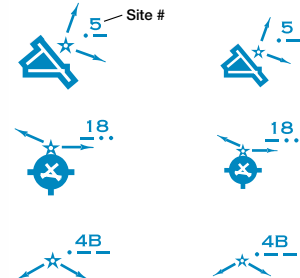

Flashing Light

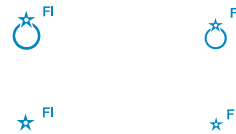

WAC

INTERSECTIONS

Named intersections used as reporting points. Arrows are directed toward facilities which establish intersection.

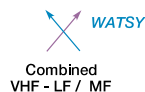

Not shown on WAC

MARINE LIGHTS

With Characteristics of Light



WAC

- R Red
- *W White
- G Green
- B Blue
- SEC Sector
- F Fixed
- Oc Single Occulting
- Oc (2) Group Occulting
- Oc (2+1) Composite Group Occulting
- Iso Isophase
- FI Flashing
- FI (2) Group Flashing
- FI (2+1) Composite Group Flashing
- Q Quick
- IQ Interrupted Quick
- Mo (A) Morse Code
- FFI Fixed and Flashing
- *Al Alternating
- Gp Group
- LFI Long Flash
- Q (3) Group Quick Flashing
- IQ Interrupted Quick Flashing
- VQ Very Quick Flashing
- VQ (3) Group Very Quick Flashing
- IVQ Interrupted Very Quick Flashing
- UQ Ultra Quick Flashing
- IUQ Interrupted Ultra Quick Flashing

*Marine Lights are white unless otherwise noted. Alternating lights are red and white unless otherwise noted.

AIRPORT BEACONS

Rotating or Flashing

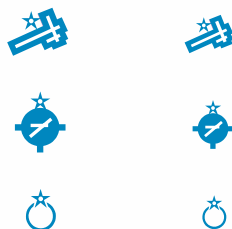

WAC





VFR AERONAUTICAL CHARTS - AERONAUTICAL INFORMATION

NAVIGATIONAL AND PROCEDURAL INFORMATION

VFR CHECKPOINTS

Underline indicates proper name of VFR Checkpoint

Pictorial **STATE CAPITOL**

SIGNAL HILL

NORTHBROOK
113.0 Ch 77 OBK

LEWIS (Pvt)
989 - 27

Not shown on WAC

VFR WAYPOINTS

RNAV



Stand-Alone



Collocated with VFR Checkpoint



Not shown on WAC

OBSTRUCTION

1473 (394) bldg	Less than 1000' AGL	1158 (553) stack
628 UC	Under Construction or reported and position / elevation unverified	507 UC
3368 (1529)	1000' AGL and higher	2967 (1697)
2144 (389)	Wind Turbine	1400 UC

WAC

GROUP OBSTRUCTION

1062 (227)	Less than 1000' AGL	1524 (567)
4977 (1432)	1000' AGL and higher	3483 (1634)
2889 (1217)	At least two in group over 1000' AGL	4892 (1573)
1164 (329) UC	Wind Turbines	1600

WAC

NAVIGATIONAL AND PROCEDURAL INFORMATION

HIGH-INTENSITY OBSTRUCTION LIGHTS

High-intensity lights may operate part-time or by proximity activation.

	Less than 1000' AGL	
	1000' AGL and higher	
	Wind Turbine	
	Group Obstruction	

WAC

WIND TURBINE FARMS

When highest wind turbine is unverified, UC will be shown after MSL value.

3624' UC	3624
----------	------

WAC

MAXIMUM ELEVATION FIGURE (MEF)

(see page 7 for explanation).

135

WARNING AND CAUTION NOTES

Used when specific area is not demarcated.

WARNING
Extensive fleet and air operations being conducted in offshore areas to approximately 100 miles seaward.

CAUTION: Be prepared for loss of horizontal reference at low altitude over lake during hazy conditions and at night.





VFR AERONAUTICAL CHARTS - AERONAUTICAL INFORMATION

CHART LIMITS

OUTLINE ON SECTIONAL OF TERMINAL AREA CHART

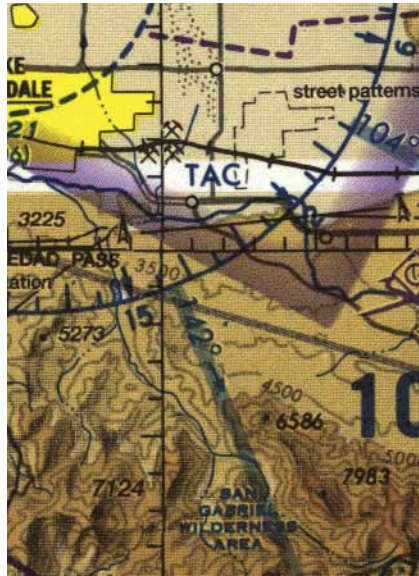

LOS ANGELES TERMINAL AREA
Pilots are encouraged to use the Los Angeles VFR Terminal Area Chart for flights at or below 10,000'

Not shown on WAC

OUTLINE ON SECTIONAL OF INSET CHART

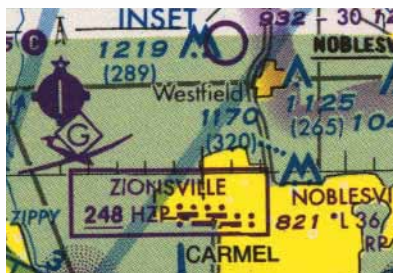

If inset chart is on a different chart:

INDIANAPOLIS INSET
See inset chart on the St. Louis Sectional for additional information

If inset chart is on the same chart as outline:

INDIANAPOLIS INSET
See inset chart for additional detail

Not shown on WAC





VFR AERONAUTICAL CHARTS - TOPOGRAPHIC INFORMATION

CULTURE

RAILROADS

Single Track



Double Track

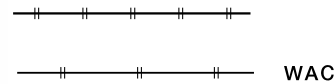

More Than Two Tracks

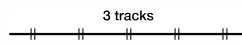

Electric

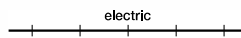

*Non-operating,
Abandoned or Under
Construction*

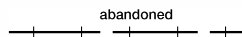

RAILROAD YARDS

Limiting Track To Scale

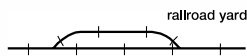

Location Only

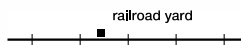

RAILROAD STATIONS

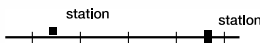

RAILROAD SIDINGS AND SHORT SPURS

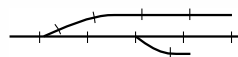

CULTURE

ROADS

*Dual-Lane Divided
Highway Category 1*



*Primary
Category 2*



*Secondary
Category 2*



TRAILS

Category 3

*Provides symbolization
for dismantled railroad
when combined with label
"dismantled railroad."*



ROAD MARKERS

Interstate Route No.



U.S. Route No.



*Air Marked
Identification Label*



ROAD NAMES

LINCOLN HIGHWAY



LINCOLN HIGHWAY

WAC

ROADS UNDER CONSTRUCTION

under construction





VFR AERONAUTICAL CHARTS - TOPOGRAPHIC INFORMATION

CULTURE

BRIDGES AND VIADUCTS

Railroad

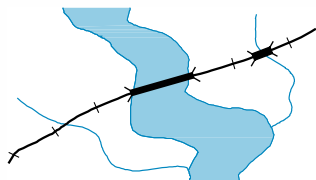

Road

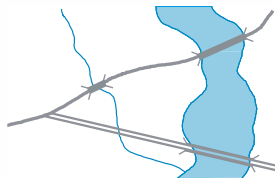

OVERPASSES AND UNDERPASSES



CAUSEWAYS



TUNNELS-ROAD AND RAILROAD

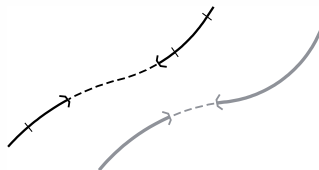

POPULATED PLACES

Large Cities Category 1

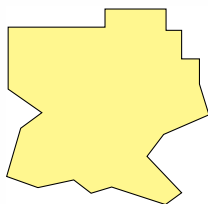

Cities and Large Towns Category 2



Towns and Villages Category 3



WAC

CULTURE

FERRIES, FERRY SLIPS AND FORDS

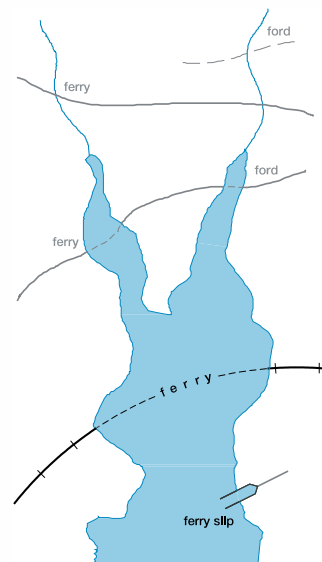

BOUNDARIES

International



State or Province



Convention or Mandate Line

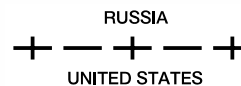

Date Line



TIME ZONES

PST
+8 (-7DT) = UTC

MST
+7 (-6DT) = UTC

Not shown on WAC

MINES OR QUARRIES

Shaft Mines or Quarries



POWER TRANSMISSION AND TELECOMMUNICATION LINES

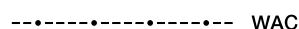



VFR AERONAUTICAL CHARTS - TOPOGRAPHIC INFORMATION

CULTURE

PIPELINES

pipeline



Underground

underground pipeline

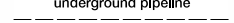

DAMS

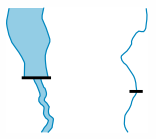

DAM CARRYING ROAD



PASSABLE LOCKS

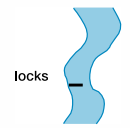

SMALL LOCKS

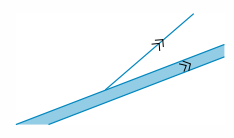

WEIRS AND JETTIES

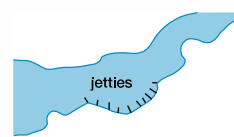

SEAWALLS

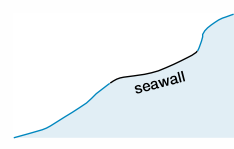

BREAKWATERS

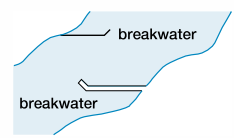

PIERS, WHARFS, QUAYS, ETC.

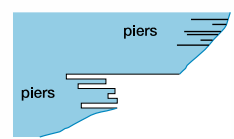

CULTURE

MISCELLANEOUS CULTURAL FEATURES

- stadium
- fort
- cemetery

OUTDOOR THEATER



WELLS

Other than water



RACE TRACKS



LOOKOUT TOWERS

⊙ 618 (Elevation Base of Tower)

LANDMARK AREAS

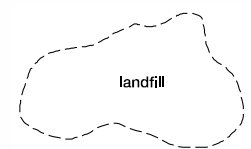

TANKS

- water
- oil
- gas

COAST GUARD STATION



AERIAL CABLEWAYS, CONVEYORS, ETC.

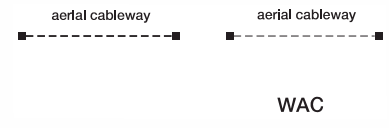

VFR AERONAUTICAL CHARTS - TOPOGRAPHIC INFORMATION

HYDROGRAPHY

OPEN WATER



INLAND WATER



OPEN/INLAND WATER

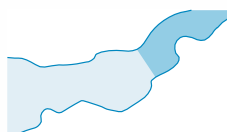

SHORELINES

Definite



Fluctuating



*Unsurveyed
Indefinite*



Man-made



LAKES

Label as required

Perennial

When too numerous to show individual lakes, show representative pattern and descriptive note. Number indicates elevation.

Non-Perennial

(dry, intermittent, etc.)

Illustration includes small perennial lake

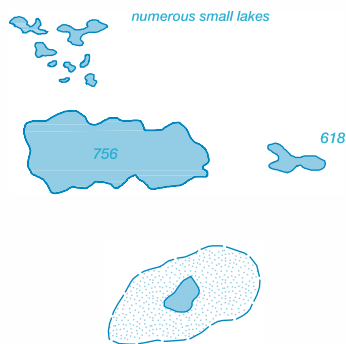

HYDROGRAPHY

RESERVOIRS

Natural Shorelines

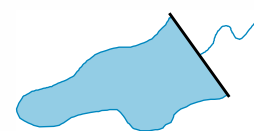

Man-made Shorelines

Label when necessary for clarity



Too small to show to scale



Under Construction

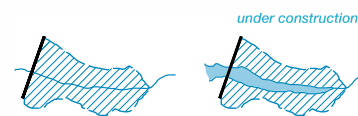

STREAMS

Perennial



Non-Perennial



*Fanned Out
Alluvial fan*



Braided



Disappearing

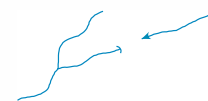

*Seasonally Fluctuating
with undefined limits*



*with maximum bank
limits, prominent
and constant*





VFR AERONAUTICAL CHARTS - TOPOGRAPHIC INFORMATION

HYDROGRAPHY

Sand Deposits in and along riverbeds



WET SAND AREAS

Within and adjacent to desert areas

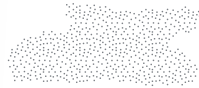

AQUEDUCTS

Abandoned or Under Construction



Underground



Suspended or Elevated



Tunnels



Kanats



Underground with air vents



FLUMES, PENSTOCKS AND SIMILAR FEATURES



Elevated

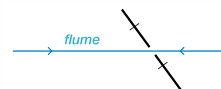

Underground



HYDROGRAPHY

FALLS

Double-Line

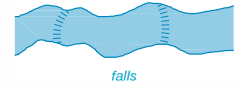

Single-Line



RAPIDS

Double-Line

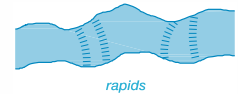

Single-Line



CANALS

ERIE



To Scale



Abandoned or Under Construction

abandoned



Abandoned to Scale

abandoned



VFR AERONAUTICAL CHARTS - TOPOGRAPHIC INFORMATION

HYDROGRAPHY

SMALL CANALS AND DRAINAGE / IRRIGATION DITCHES

Perennial

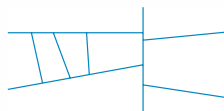

Non-Perennial



Abandoned or Ancient

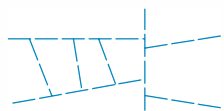

Numerous

Representative pattern and/or descriptive note.

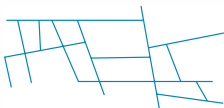

Numerous

numerous canals and ditches

SALT EVAPORATORS AND SALT PANS MAN EXPLOITED

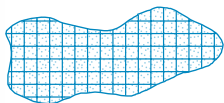

SWAMPS, MARSHES AND BOGS

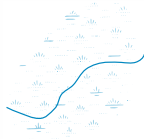

HUMMOCKS AND RIDGES



MANGROVE AND NIPA



PEAT BOGS



peat bog

HYDROGRAPHY

TUNDRA

tundra

CRANBERRY BOGS

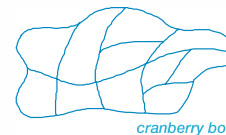

cranberry bog

RICE PADDIES

Extensive areas indicated by label only.



LAND SUBJECT TO INUNDATION



SPRINGS, WELLS AND WATERHOLES



GLACIERS



GLACIAL MORAINES

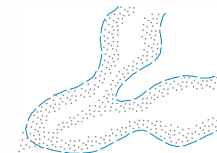

ICE CLIFFS

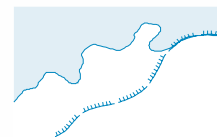

SNOWFIELDS, ICE FIELDS AND ICE CAPS

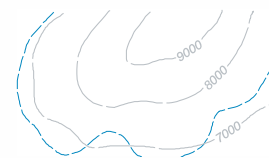

ICE PEAKS





VFR AERONAUTICAL CHARTS - TOPOGRAPHIC INFORMATION

HYDROGRAPHY

FORESHORE FLATS
Tidal flats exposed at low tide.



ROCKS-ISOLATED
Bare or Awash



WRECKS
Exposed



REEFS-ROCKY OR CORAL

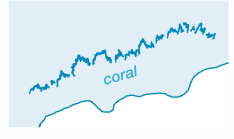

MISCELLANEOUS UNDERWATER FEATURES NOT OTHERWISE SYMBOLIZED

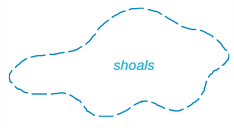

FISH PONDS AND HATCHERIES

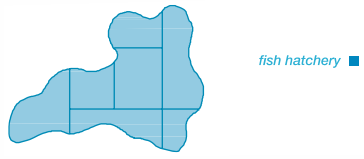

HYDROGRAPHY

ICE

Permanent Polar Ice

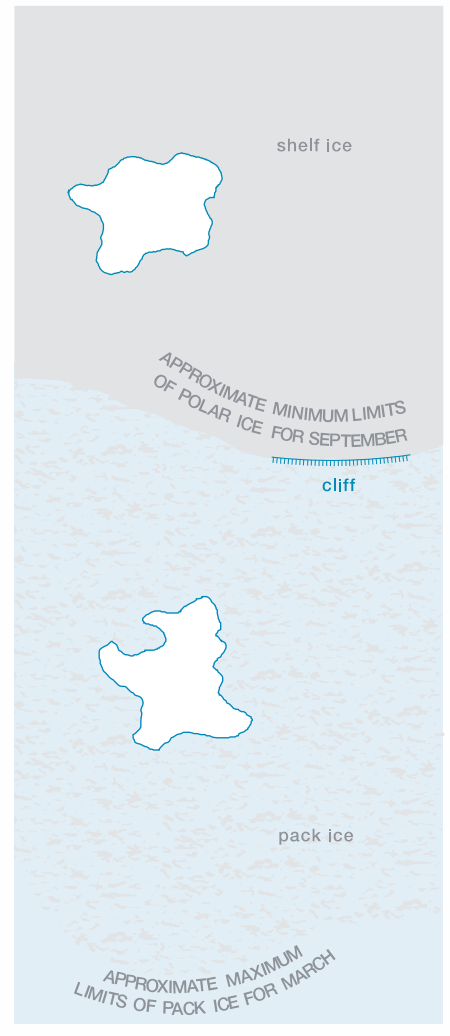

Pack Ice



VFR AERONAUTICAL CHARTS - TOPOGRAPHIC INFORMATION

	RELIEF
CONTOURS <i>Basic</i>	
<i>Approximate</i>	
<i>Intermediate</i>	
<i>Auxiliary</i>	
<i>Depression</i> <i>(Illustration includes mound within depression)</i>	
<i>Values</i>	

	RELIEF
SPOT ELEVATIONS <i>Position Accurate</i>	
<i>Position Accurate, Elevation Approximate</i>	
<i>Highest in General Area</i>	
<i>Highest on Chart</i>	

	RELIEF
MOUNTAIN PASS	
HACHURING	
UNSURVEYED AREAS <i>Label appropriately as required</i>	
UNCONTOURED AREAS <i>Label appropriately as required</i>	
DISTORTED SURFACE AREAS	
LAVA FLOWS	
SAND OR GRAVEL AREAS	
SAND RIDGES <i>To Scale</i>	
SAND DUNES <i>To Scale</i>	

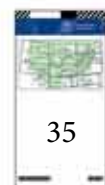

VFR AERONAUTICAL CHARTS - TOPOGRAPHIC INFORMATION

RELIEF

SHADED RELIEF



ROCK STRATA OUTCROP



QUARRIES TO SCALE

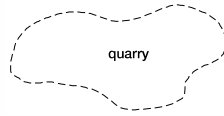

STRIP MINES, MINE DUMPS AND TAILINGS

To Scale



CRATERS

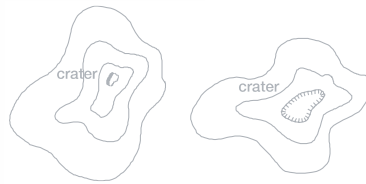

ESCARPMENTS, BLUFFS, CLIFFS, DEPRESSIONS, ETC.

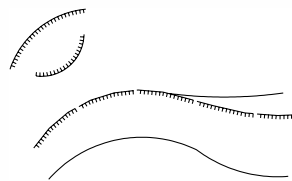

LEVEES AND ESKERS





VFR AERONAUTICAL CHART SYMBOLS

HELICOPTER ROUTE CHARTS

AIRPORTS.....	38
RADIO AIDS TO NAVIGATION.....	38
AIRSPACE INFORMATION.....	39
NAVIGATIONAL AND PROCEDURAL INFORMATION	42
CULTURE.....	43
HYDROGRAPHY.....	43
RELIEF.....	43

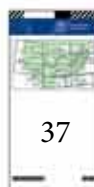



HELICOPTER ROUTE CHARTS - AERONAUTICAL INFORMATION

AIRPORTS

LANDPLANE

All recognizable runways, including some which may be closed, are shown for visual identification.



Public



Private



HELIPORT

Heliports public and private



Hospital Helipads



Trauma Center



Helipads located at major airports (when requested)



SEAPLANE



ULTRALIGHT FLIGHT PARK



AIRPORT DATA GROUPING

Boxed airport name indicates airport for which a Special Traffic Rule has been established. (Pvt): Non-public use having emergency or landmark value. "OBJECTIONABLE": This airport may adversely affect airspace use.

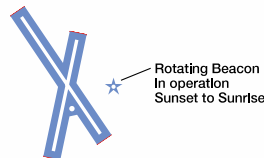

FSS NO SVFR [NAME] (NAM) (PNAM) CT-119.1 * 119.8 (HELI) ATIS 115.4 ASOS/AWOS 135.42 03 L 122.95 AOE

- FSS - Flight Service Station on field
- NO SVFR - Airspace where fixed wing special visual flight rules operations are prohibited (shown above airport name) F.A.R. 91.
- [] - Indicates F.A.R. 93 Special Air Traffic Rules and Airport Traffic
- (NAM) - Location Identifier
- (PNAM) - ICAO Location Identifier
- CT - 119.1 - Control Tower (CT) - primary frequency
- * - Star indicates operation part-time. See tower frequencies tabulation for hours of operation.
- ATIS 115.4 - Automatic Terminal Information Service
- ASOS/AWOS 135.42 - Automated Surface Weather Observing Systems (shown when full-time ATIS is not available.) Some ASOS/AWOS facilities may not be located at airports.
- 03 - Elevation in feet
- L - Lighting in operation Sunset to Sunrise
- *L - Lighting limitations exist, refer to Airport/Facility Directory.
- 122.95 - UNICOM - Aeronautical advisory station
- (Unverified) - Follows the Common Traffic Advisory Frequency (CTAF)
- (Unverified) - Unverified Heliport
- AOE - Airport of Entry

When lighting is lacking, the respective character is replaced by a dash. Lighting codes refer to runway edge lights and may not represent the longest runway or full length lighting. Dashes are not shown on heliports or helipads unless additional information follows the elevation (e.g. UNICOM, CTAF).

RADIO AIDS TO NAVIGATION

VHF OMNI-DIRECTIONAL RADIO (VOR) RANGE

VOR-DME PROVO 108.4 Ch 21 PVU

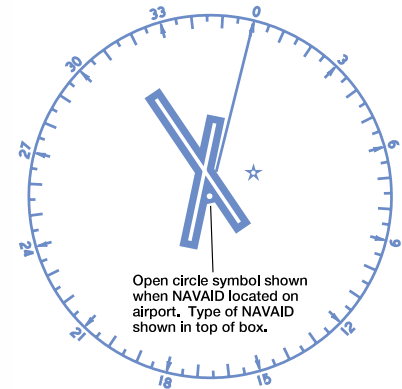

Compass Rose is "reference" oriented to magnetic north.

VOR

Operates less than continuous or On-Request Transcribed Weather Broadcast (TWEB)

AMEDEE *109.0 Ch 27 AHC

Underline indicates no voice on this frequency.

VORTAC

When an NDB NAVAID shares the same name and Morse Code as the VOR NAVAID the frequency can be collocated inside the same box to conserve space.

NDB Frequency Name ASOS/AWOS 379 111.0 Ch 47 PTK Morse Code

VOR-DME

Hazardous Inflight Weather Advisory Service (HIWAS)

SALEM Ch 33 SVM

Crosshatch Indicates Shutdown status

NON-DIRECTIONAL RADIO BEACON (NDB)



MONTAGUE 382 MOG

Underline indicates no voice on this frequency.

NDB-DME



GAMBELL 369 GAM DME Ch 92 (114.5)



HELICOPTER ROUTE CHARTS - AERONAUTICAL INFORMATION

RADIO AIDS TO NAVIGATION

NAVAIDS USED TO DEFINE CLASS B AIRSPACE

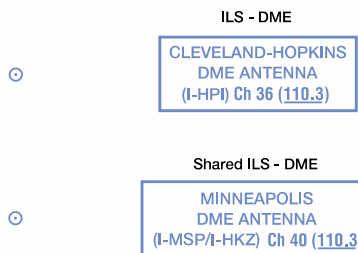

BROADCAST STATIONS (BS)

On request by the proper authority or when a VFR Checkpoint.



FLIGHT SERVICE STATION (FSS)

Heavy line box indicates Flight Service Station (FSS). Frequencies 121.5, 122.2, 243.0 and 255.4 (Canada - 121.5, 126.7 and 243.0) are available at many FSSs and are not shown above boxes. All other frequencies are shown. Certain FSSs provide Airport Advisory Service, see A/FD. R - Receive only



No NAVAID of the same name as FSS

or



FSS oper 0600-2200 Rancho Murieta FSS other times.

NAVAID same name as FSS but not an RCO

REMOTE COMMUNICATIONS OUTLET (RCO)

Frequencies above thin line box are remotod to NAVAID site. Other FSS frequencies providing voice communication may be available as determined by altitude and terrain. Consult Airport/Facility Directory for complete information.

Thin line box without frequencies and controlling FSS name indicates no FSS frequency available.

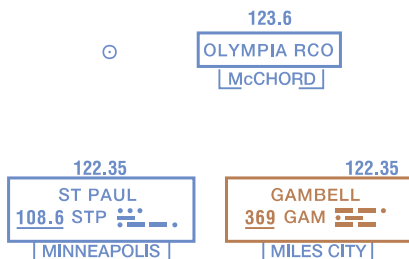

FSS radio providing voice communication

AIRSPACE INFORMATION

CLASS B AIRSPACE

Appropriate notes as required may be shown. (Mode C see FAR 91.215/AIM)

All mileages are nautical (NM)

All radials are magnetic.

LAS VEGAS CLASS B

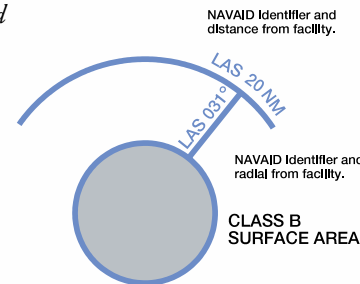

70 SFC

- Ceiling of Class B in hundreds of feet MSL
- Floor of Class B in hundreds of feet MSL

(Floors extending "upward from above" a certain altitude are preceded by a +. Operations at and below these altitudes are outside of Class B Airspace.)

CTC LAS VEGAS APP ON 121.1 OR 257.8

CLASS C AIRSPACE

Appropriate notes as required may be shown. (Mode C see FAR 91.215/AIM)

BURBANK CLASS C

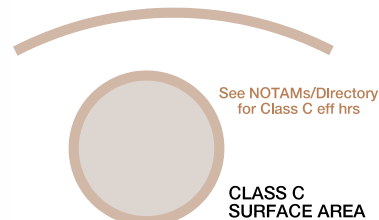

70 30

- Ceiling of Class C in hundreds of feet MSL
- Floor of Class C in hundreds of feet MSL

T SFC

- Ceiling is to but not including floor of Class B
- Surface

CTC BURBANK APP WITHIN 20 NM ON 124.6 395.9

CLASS D AIRSPACE

See NOTAMS/Directory for Class D eff hrs



See NOTAMS/Directory for Class D/E (sfc) eff hrs



(A minus in front of the figure is used to indicate "from surface to but not including...")

ALTITUDES IN HUNDREDS OF FEET MSL

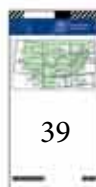



HELICOPTER ROUTE CHARTS - AERONAUTICAL INFORMATION

AIRSPACE INFORMATION

CLASS E SURFACE (SFC) AIRSPACE

See NOTAMs/Directory for Class E (sfc) eff hrs

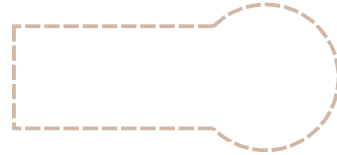

SPECIAL AIRSPACE AREAS

SPECIAL FLIGHT RULES AREA (SFRA) RELATING TO NATIONAL SECURITY

Example: Washington DC

Appropriate notes as required may be shown.

Note. Delimiting line not shown when it coincides with International Boundary, projection lines or other linear features.



Washington DC Metropolitan Area Special Flight Rules Area/Flight Restricted Zone restrictions are in effect. Special regulations apply to all aircraft operations from the surface to but not including Flight Level 180 in the Washington DC Metropolitan Area. Pilots should contact a local FSS for NOTAM information prior to flight in the Washington DC Metropolitan Area.

FLIGHT RESTRICTED ZONE (FRZ) RELATING TO NATIONAL SECURITY

Example: Washington DC



AIR DEFENSE IDENTIFICATION ZONE (ADIZ)

Note. Delimiting line not shown when it coincides with International Boundary, projection lines or other linear features.

CONTIGUOUS U.S. ADIZ



AIRSPACE INFORMATION

CANADIAN AIRSPACE

Appropriate notes as required may be shown.

TCA Class B/C/D



80 - Ceiling of TCA Class B/C/D in hundreds of feet MSL
40 - Floor of TCA Class B/C/D in hundreds of feet MSL

Class C or D Control Zone

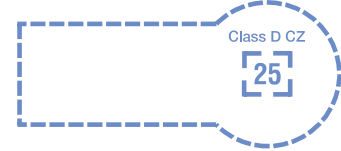

ALTITUDE IN HUNDREDS OF FEET MSL

Class E Control Zone



AIRSPACE CLASSIFICATION (SEE CANADA FLIGHT SUPPLEMENT) AND OPERATIONAL REQUIREMENTS (DOD USERS, SEE DOD AREA PLANNING AP/1) MAY DIFFER BETWEEN CANADA AND UNITED STATES

NOTE: REFER TO CURRENT CANADIAN CHARTS AND FLIGHT INFORMATION PUBLICATIONS FOR INFORMATION WITHIN CANADIAN AIRSPACE

HELICOPTER ROUTES

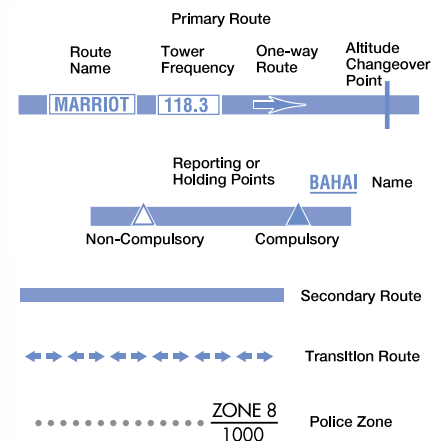

Recommended Route Altitude

- 500 Maximum
- 500 Minimum
- 500 Recommended



HELICOPTER ROUTE CHARTS - AERONAUTICAL INFORMATION

AIRSPACE INFORMATION

SPECIAL USE AIRSPACE

Only the airspace effective below 18,000 feet MSL is shown.

The type of area shall be spelled out in large areas if space permits.



PROHIBITED, RESTRICTED or WARNING AREA



MILITARY OPERATIONS AREA (MOA) or ALERT AREA

MILITARY TRAINING ROUTES (MTR)



SPECIAL AIR TRAFFIC RULES / AIRPORT TRAFFIC AREAS (FAR PART 93)

Appropriate boxed notes as required shown adjacent to area.



SPECIAL NOTICE
Pilots are required to obtain an ATC clearance prior to entering this area.

MODE C (FAR 91.215)

Appropriate notes as required may be shown.



MISCELLANEOUS AIRSPACE AREAS

Parachute Jumping Area with Frequency



Glider Operating Area



Ultralight Activity



Hang Glider Activity



Unmanned Aircraft Activity



AIRSPACE INFORMATION

SPECIAL CONSERVATION AREAS

National Park, Wildlife Refuge, Primitive and Wilderness Areas, etc.



NOAA Regulated National Marine Sanctuary Designated Areas

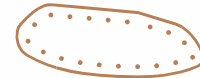

Flight operations below 1000' AGL over the designated areas within the Gulf of Farallones National Marine Sanctuary violate NOAA regulations (see 15 CFR 922).

TERMINAL RADAR SERVICE AREA (TRSA)

Appropriate notes as required may be shown.

PALM SPRINGS TRSA

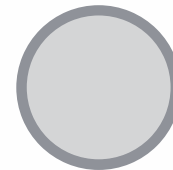

TRSA SURFACE AREA

SEE TWR FREQ TAB

80 - Ceiling of TRSA in hundreds of feet MSL
40 - Floor of TRSA in hundreds of feet MSL





HELICOPTER ROUTE CHARTS - AERONAUTICAL INFORMATION

NAVIGATIONAL AND PROCEDURAL INFORMATION

VFR CHECKPOINTS

Underline indicates proper name of VFR Checkpoint

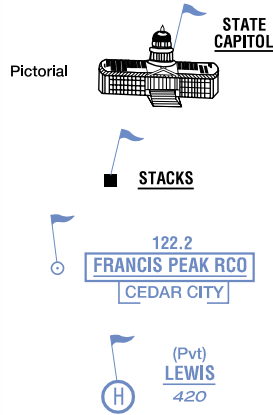

VFR WAYPOINTS

Stand-Alone



Collocated with VFR Checkpoint



Collocated with VFR Checkpoint & Reporting Point



OBSTRUCTIONS

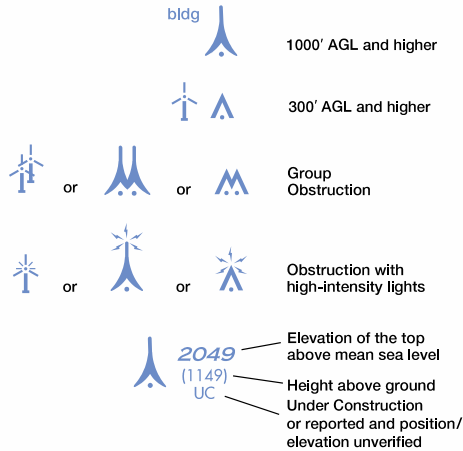

WIND TURBINE FARMS

When highest wind turbine is unverified, UC will be shown after MSL value.

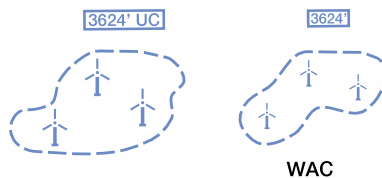

NAVIGATIONAL AND PROCEDURAL INFORMATION

MAXIMUM ELEVATION

FIGURE (MEF)

(see page 7 for explanation).

124

NAVIGATION DATA

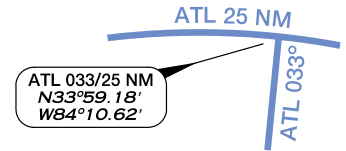

WARNING AND CAUTION NOTES

WARNING
Extensive fleet and air operations being conducted in offshore areas to approximately 100 miles seaward.

CAUTION: Be prepared for loss of horizontal reference at low altitude over lake during hazy conditions and at night.

LOCAL MAGNETIC NOTES

Unreliability Notes

Magnetic disturbance of as much as 78° exists at ground level and 10° or more at 3000 feet above ground level in this vicinity.



HELICOPTER ROUTE CHARTS - TOPOGRAPHIC INFORMATION

CULTURE

RAILROADS

Single Track



Double Track



ROADS

Dual-Lane:



Divided Highways



Major Boulevards & Major Streets



Primary



BRIDGES

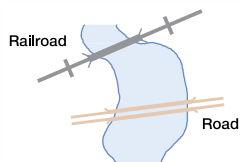

POPULATED PLACES

Built-up Areas

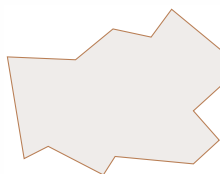

BOUNDARIES

International



State or Province



POWER

TRANSMISSION LINES



PROMINENT PICTORIALS



LANDMARKS

- Landmark-stadium, factory, school, etc.
- ⚠ Mines or Quarries
- 🎪 Outdoor Theater
- 🗼 Lookout Tower
- 🏎 Race Track
- Tank-water, oil or gas

HYDROGRAPHY

SHORELINES



MAJOR LAKES AND RIVERS



RESERVOIRS

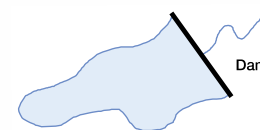

RELIEF

SPOT ELEVATIONS

Position Accurate





VFR AERONAUTICAL CHART SYMBOLS

VFR FLYWAY PLANNING CHARTS

AIRPORTS.....	45
RADIO AIDS TO NAVIGATION.....	45
AIRSPACE INFORMATION.....	46
NAVIGATIONAL AND PROCEDURAL INFORMATION.....	48
CULTURE.....	49
HYDROGRAPHY.....	49
RELIEF.....	49





VFR FLYWAY PLANNING CHARTS - AERONAUTICAL INFORMATION

AIRPORTS

LANDPLANE

No distinction is made between airports with services and those without services. Runways may be exaggerated to clearly portray the pattern. Hard-surfaced runways which are closed but still exist are included in the charted pattern.

FAR 91 - Fixed wing special VFR operations prohibited.

(Pvt): Non-public use having emergency or landmark value. "OBJECTIONABLE": This airport may adversely affect airspace use.

ABANDONED - Depicted for landmark value or to prevent confusion with an adjacent usable landing area. Only portrayed beneath or close to the VFR flyway routes or requested by the FAA. (Normally at least 3000' paved).

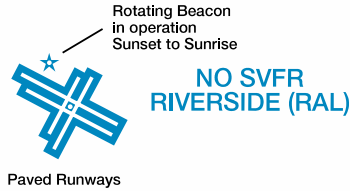

Paved Runways



Unpaved Runways



RADIO AIDS TO NAVIGATION

VHF OMNI-DIRECTIONAL RADIO RANGE (VOR)

VOR



VORTAC



VOR-DME

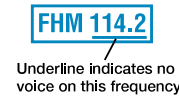

NON-DIRECTIONAL RADIO BEACON (NDB)

NDB-DME

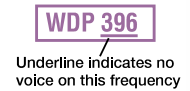

NAVAIDS USED TO DEFINE CLASS B AIRSPACE



ILS - DME

Shared ILS - DME



VFR FLYWAY PLANNING CHARTS - AERONAUTICAL INFORMATION

AIRSPACE INFORMATION

CLASS B AIRSPACE

Appropriate notes as required may be shown.

(Mode C see FAR 91.215 /AIM)

All mileages are nautical (NM).

All radials are magnetic.

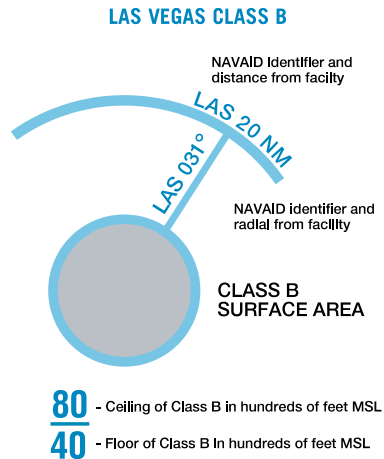

(Floors extending "upward from above" a certain altitude are preceded by a +. Operations at and below these altitudes are outside of Class B Airspace.)

CLASS C AIRSPACE

Appropriate notes as required may be shown.

(Mode C see FAR 91.215/AIM)

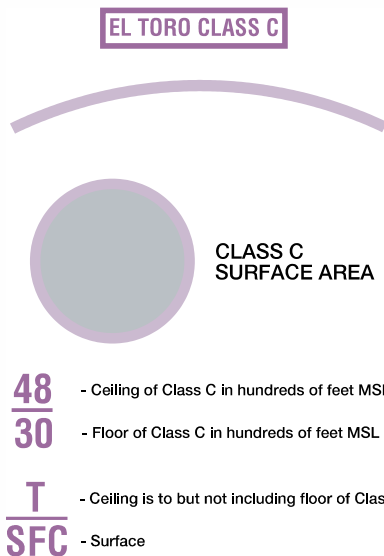

CLASS D AIRSPACE

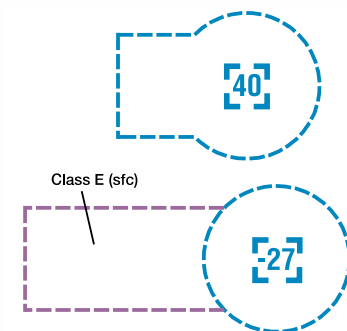

(A minus in front of the figure is used to indicate "from surface to but not including...")

ALTITUDE IN HUNDREDS OF FEET MSL

AIRSPACE INFORMATION

CLASS E SURFACE (SFC) AIRSPACE



SPECIAL AIRSPACE AREAS

SPECIAL FLIGHT RULES AREA (SFRA) RELATING TO NATIONAL SECURITY

Example:
Washington DC



Washington DC Metropolitan Area Special Flight Rules Area/Flight Restricted Zone restrictions are in effect. Special regulations apply to all aircraft operations from the surface to but not including Flight Level 180 in the Washington DC Metropolitan Area. Pilots should contact a local FSS for NOTAM information prior to flight in the Washington DC Metropolitan Area.

Appropriate notes as required may be shown.
Note. Delimiting line not shown when it coincides with International Boundary, projection lines or other linear features.

FLIGHT RESTRICTED ZONE (FRZ) RELATING TO NATIONAL SECURITY

Example:
Washington DC





VFR FLYWAY PLANNING CHARTS - AERONAUTICAL INFORMATION

AIRSPACE INFORMATION

TEMPORARY FLIGHT RESTRICTION (TFR) RELATING TO NATIONAL SECURITY

Example:



Appropriate notes as required may be shown.

CAUTION
P-40 AND R-4009 EXPANDED BY TEMPORARY FLIGHT RESTRICTION. CONTACT AFSS FOR LATEST STATUS AND NOTAMS.

AIR DEFENSE IDENTIFICATION ZONE (ADIZ)

Note. Delimiting line not shown when it coincides with International Boundary, projection lines or other linear features.



SUGGESTED VFR FLYWAY AND ALTITUDE

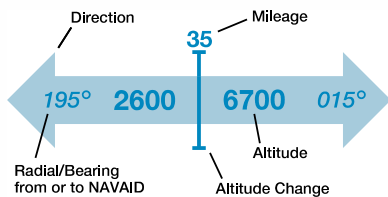

IFR ROUTES

Arrival



Departure



AIRSPACE INFORMATION

VFR TRANSITION ROUTES

Appropriate notes as required may be shown.

VFR TRANSITION ROUTE
ATC CLEARANCE REQUIRED
SEE SHOWBOAT GRAPHIC
ON SIDE PANEL

Uni-directional



Bi-directional



SPECIAL USE AIRSPACE

Only the airspace effective below 18,000 feet MSL is shown.



PROHIBITED, RESTRICTED or WARNING AREA

The type of area shall be spelled out in large areas if space permits.

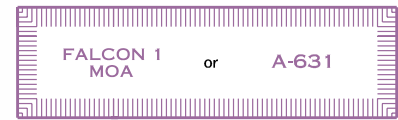

MILITARY OPERATIONS AREA (MOA) or ALERT AREA

MILITARY TRAINING ROUTES (MTR)



SPECIAL AIR TRAFFIC RULES/AIRPORT TRAFFIC AREAS (FAR Part 93)

Appropriate boxed note as required shown adjacent to area.



MODE C (FAR 91.215)

Appropriate notes as required may be shown.



TERMINAL RADAR SERVICE AREA (TRSA)

PALM SPRINGS TRSA

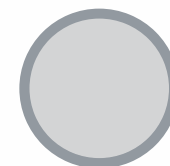

TRSA SURFACE AREA

100 - Ceiling of TRSA in hundreds of feet MSL
90 - Floor of TRSA in hundreds of feet MSL





VFR FLYWAY PLANNING CHARTS - AERONAUTICAL INFORMATION

AIRSPACE INFORMATION

MISCELLANEOUS AIRSPACE AREAS

Parachute Jumping Area



Glider Operating Area



Ultralight Activity



Hang Glider Activity



Unmanned Aircraft Activity



SPECIAL CONSERVATION AREAS

NOAA Regulated National Marine Sanctuary Designated Areas



Flight operations below 1000' AGL over the designated areas within the Gulf of Farallones National Marine Sanctuary violate NOAA regulations (see 15 CFR 922).

NAVIGATIONAL AND PROCEDURAL INFORMATION

VFR CHECKPOINTS

Underline indicates proper name of VFR Checkpoint

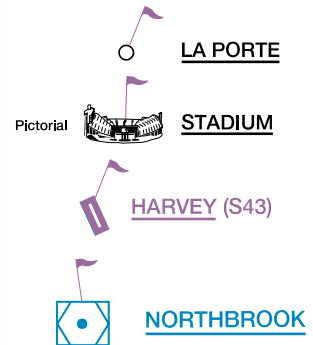

VFR WAYPOINTS

Stand-Alone



Collocated with VFR Checkpoint



OBSTRUCTIONS

Only obstacles greater than 999' above ground level (AGL) or specified by the local ATC Facility shall be shown.

AGL heights are not shown. High-intensity lights may operate part-time or by proximity activation.

Under Construction or reported and position/ elevation unverified.

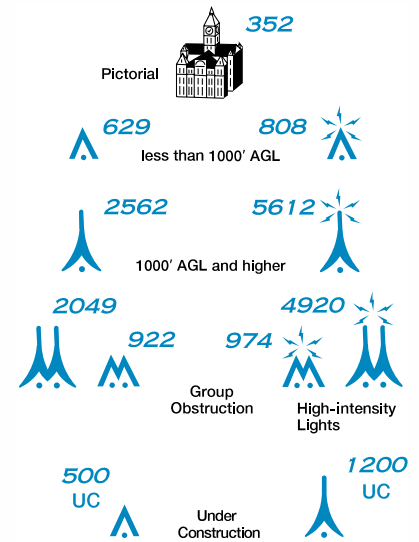

NAVIGATIONAL DATA

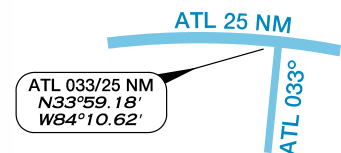



AIRSPACE CLASSES

AIRSPACE	CLASS A	CLASS B	CLASS C	CLASS D	CLASS E	CLASS G
Entry Requirements	ATC clearance	ATC clearance	ATC clearance for IFR All require radio contact	ATC clearance for IFR All require radio contact	ATC clearance for IFR All IFR require radio contact	None
Minimum Pilot Qualifications	Instrument Rating	Private or Student certification. Local restrictions apply.	Student certificate	Student certificate	Student certificate	Student certificate
Two-Way Radio Communications	Yes	Yes	Yes	Yes	Yes, under IFR flight plan*	Not required*
Special VFR Allowed	No	Yes	Yes	Yes	Yes	N/A
VFR Visibility Minimum	N/A	3 statute miles	3 statute miles	3 statute miles	Below 10,000' MSL 3 statute miles At or above 10,000' MSL 5 statute miles	Below 1200' AGL (regardless of MSL) Day 1 statute mile Night 3 statute miles Above 1200' AGL & below 10,000' MSL Day 1 statute mile Night 3 statute miles Above 1200' AGL & at or above 10,000' MSL 5 statute miles
VFR Minimum Distance From Clouds	N/A	Clear of Clouds	500' below 1000' above 2000' horizontally	500' below 1000' above 2000' horizontally	Below 10,000' MSL 500' below 1000' above 2000' horizontally At or above 10,000' MSL 1000' below 1000' above 1 mile horizontally	Below 1200' AGL (regardless of MSL) Day Clear of Clouds Night 500' below 1000' above 2000' horizontally Above 1200' AGL & below 10,000' MSL Day 500' below 1000' above 2000' horizontally Night 500' below 1000' above 2000' horizontally Above 1200' AGL & at or above 10,000' MSL 1000' below 1000' above 1 mile horizontally
VFR Aircraft Separation	N/A	All	IFR Aircraft	Runway Operations	None	None
Traffic Advisories	Yes	Yes	Yes	Workload permitting	Workload permitting	Workload permitting
Airport Application	N/A	Radar Instrument Approaches Weather Control Tower High Density	Radar Instrument Approaches Weather Control Tower	Instrument Approaches Weather Control Tower	Instrument Approaches Weather	Control Tower
Speed Restrictions	N/A	250 KIAS below 10000' MSL	250 KIAS below 10,000' MSL and 200 KIAS below 2500' AGL within 4nm of the primary airport	250 KIAS below 10,000' MSL and 200 KIAS below 2500' AGL within 4nm of the primary airport	N/A	N/A
Differs from ICAO	No	ICAO does not have speed restriction	ICAO does not have speed restriction ICAO requires ATC clearance	ICAO requires ATC clearance	No	ICAO requires 3 statute miles visibility

* Unless a temporary tower is present





AIRSPACE CLASSIFICATION

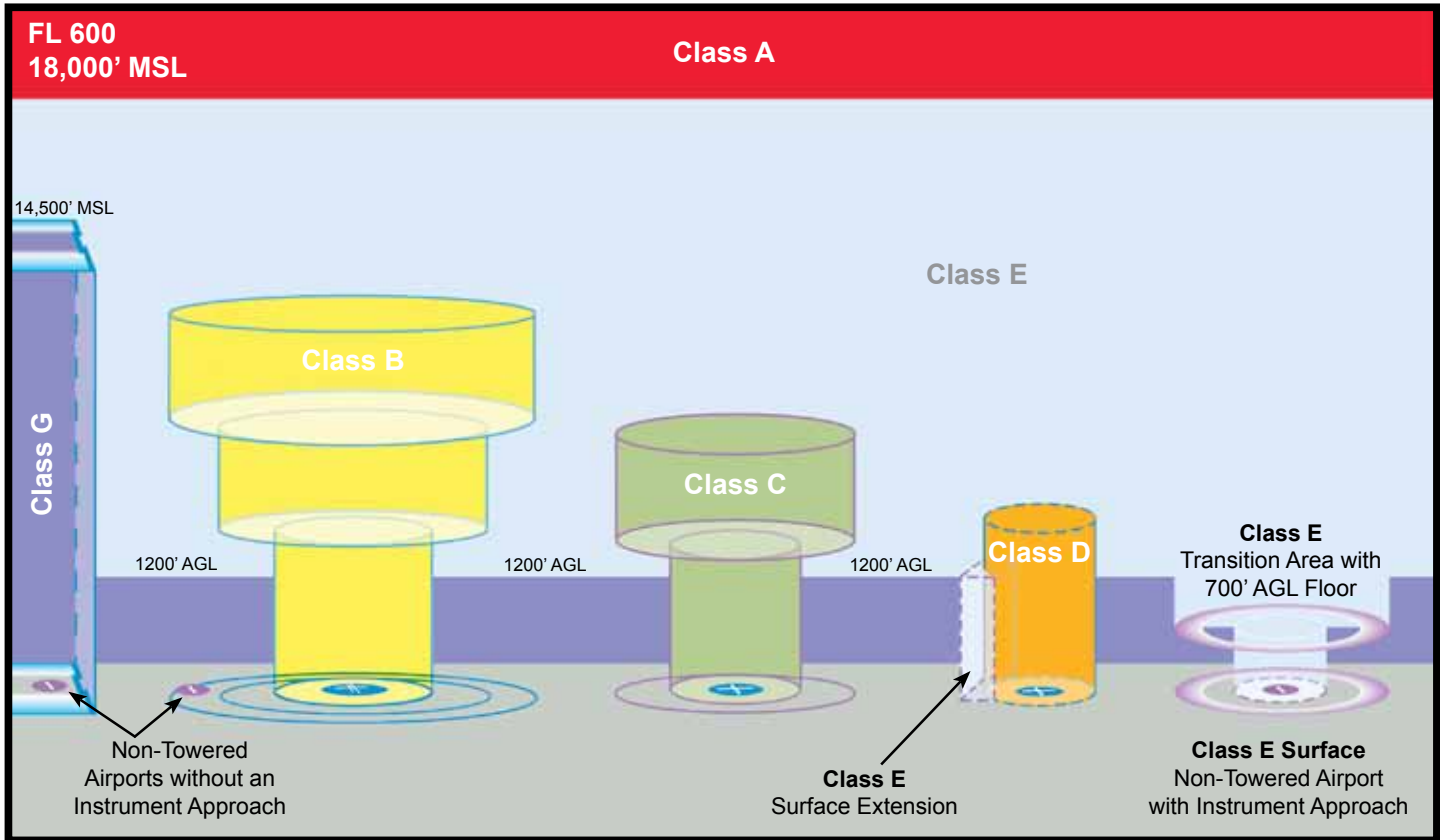

U.S. Airspace depiction as shown on Visual Aeronautical Charts

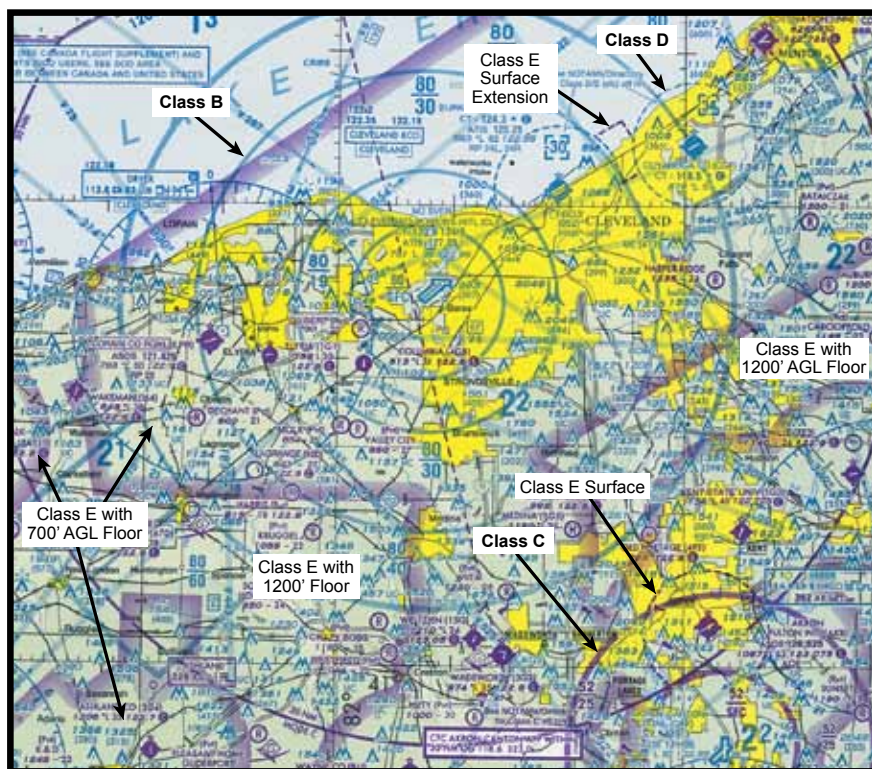

Excerpt from Detroit Sectional Chart

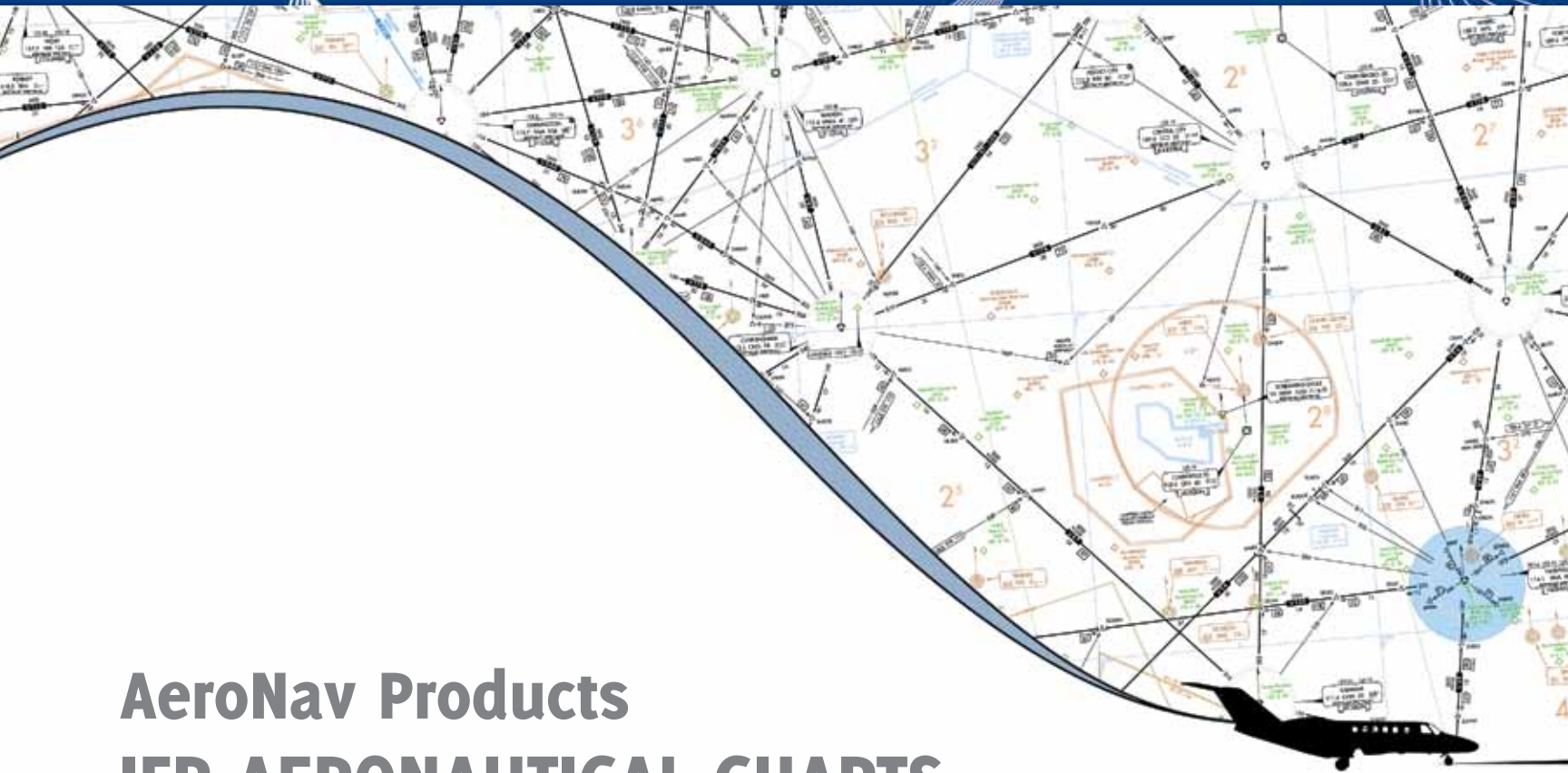

AeroNav Products

IFR AERONAUTICAL CHARTS





IFR AERONAUTICAL CHARTS

EXPLANATION OF IFR Enroute TERMS AND SYMBOLS

FAA charts are prepared in accordance with specifications of the Interagency Air Cartographic Committee (IACC), and are approved by representatives of the Federal Aviation Administration and the Department of Defense (DoD). Some information on these charts may only apply to military pilots.

The explanations of symbols used on Instrument Flight Rule (IFR) Charts and examples in this section are based primarily on the IFR Enroute Low Altitude Charts. Other IFR products use similar symbols in various colors (see Section 3 of this guide). The chart legends portray aeronautical symbols with a brief description of what each symbol depicts. This section provides more details of the symbols and how they are used on IFR charts.

AIRPORTS

Active airports with hard-surfaced runways of 3,000' or longer are shown on IFR Enroute Low Altitude Charts - U.S. for the contiguous United States. Airports with hard or soft runways of 3,000' or longer are shown on IFR Enroute Low Altitude Charts - Alaska. Airports with hard-surfaced runways of 5,000' or longer are shown on IFR Enroute High Altitude Charts - U.S. for the contiguous United States. Airports with hard or soft runways of 4000' or longer are shown on IFR Enroute High Altitude Charts - Alaska. Public heliports with an Instrument Approach Procedure (IAP) or requested by the FAA or DoD are depicted on the IFR Enroute Low Altitude Charts. Seaplane bases requested by the FAA or DoD are depicted on the IFR Enroute Low Altitude Charts. Active airports with approved instrument approach procedures are also shown regardless of runway length or composition. On IFR Enroute Low Altitude Charts a tabulation, is provided which identifies airport names, IDs and the panels they are located on. Charted airports are classified according to the following criteria:



- Blue** – Airports with an Instrument Approach Procedure and/or RADAR MINIMA published in the high altitude DoD Flight Information Publications (FLIPs)
- Green** – Airports which have an approved Instrument Approach Procedure and/or RADAR MINIMA published in either the U.S. Terminal Procedures Publications (TPPs) or the DoD FLIPs
- Brown** – Airports without a published Instrument Approach Procedure or RADAR MINIMA

Airports are plotted at their true geographic position, unless the symbol conflicts with a radio aid to navigation (NAVAID) at the same location. In such cases, the airport symbols are displaced. The relationship between the airport and the NAVAID is retained.

Airports are identified by the airport name. In the case of military airports, Air Force Base (AFB), Naval Air Station (NAS), Naval Air Facility (NAF), Marine Corps Air Station (MCAS), Army Air Field (AAF), etc., the abbreviated letters appear as part of the airport name.

Airports marked "Pvt" immediately following the airport name are not for public use, but otherwise meet the criteria for charting as specified above.

Runway length is the length of the longest active runway (including displaced thresholds but excluding overruns) and is shown to the nearest 100 feet using 70 feet as the division point; e.g., a runway of 8,070' is labeled 81.

The following runway compositions (materials) constitute a hard-surfaced runway: asphalt, bitumen, chip seal, concrete, and tar macadam. Runways that are not hard-surfaced have a small letter "s" following the runway length, indicating a soft surface.

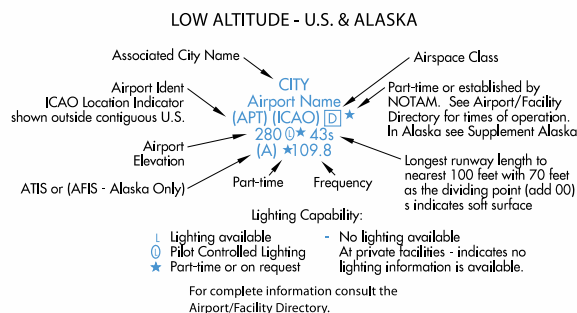

- Airport elevation given in feet above or below mean sea level.
- Pvt - Private use, not available to general public.
- A solid line box enclosing the airport name indicates FAR 93 Special Requirements - see Directory/Supplement
- "NO SVFR" above the airport name indicates FAR 91 fixed-wing special VFR flight is prohibited
- [L] or [D] following the airport identifier indicates Class C or Class D Airspace.
- Airport symbol may be offset for enroute navigational aids.
- Associated city names for public airports are shown above or preceding the airport name. If airport name and city name are the same, only the airport name is shown. The airport identifier in parentheses follows the airport name. City names for military and private airports are not shown.

A L symbol following the elevation under the airport name means that runway lights are in operation sunset to sunrise. A @ symbol indicates there is Pilot Controlled Lighting. A L* symbol means the lighting is part-time or on request, the pilot should consult the Airport/Facility Directory (A/FD) or appropriate Supplement for light operating procedures. The Aeronautical Information Manual (AIM) thoroughly explains the types and uses of airport lighting aids.

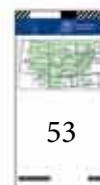



RADIO AIDS TO NAVIGATION (NAVAIDS)

All IFR radio NAVAIDS that have been flight checked and are operational are shown on all IFR Enroute Charts. Very High Frequency/Ultrahigh Frequency (VHF/UHF) NAVAIDS, Very high frequency Omnidirectional Radio range (VORs), Tactical Air Navigation (TACANs) are shown in black, and Low Frequency/Medium Frequency (LF/MF) NAVAIDS, (Compass Locators and Aeronautical or Marine NDBs) are shown in brown.

On IFR Enroute Charts, information about NAVAIDS is boxed as illustrated below. To avoid duplication of data, when two or more NAVAIDS in a general area have the same name, the name is usually printed only once inside an identification box with the frequencies, TACAN channel numbers, identification letters, or Morse Code Identifications of the different NAVAIDS are shown in appropriate colors.

NAVAIDS in a shutdown status have the frequency and channel number crosshatched. Use of the NAVAID status "shutdown" is only used when a facility has been decommissioned but cannot be published as such because of pending airspace actions.

VOR with TACAN compatible DME
 Underline indicates No Voice transmitted on this frequency. TACAN Channels are without voice but not underlined.
 Crosshatch indicates Shutdown status
 (T) Frequency protection usable range at 12,000' AGL - 25NM
 (Y) TACAN must be placed in "Y" mode to receive distance information

TACAN Channel paired with VHF Frequency in parenthesis.
 Automated Weather Broadcast Systems:
 ASOS/AWOS HIWAS TWEB
 Automated weather, when available, is broadcast on the associated NAVAID frequency.
 Stand Alone ASOS/AWOS
 Part-Time or On-Request
 LF/MF Non-directional Radiobeacon/DME VHF Freq paired with TACAN Channel

FSS name and identifier not associated with NAVAID
 Remote Communications Outlet (RCO). FSS radio name and remoted freq(s) are shown.
 SHADOW BOXES indicate Flight Service Stations (FSS). Frequencies 122.2, 255.4 and emergency 121.5 and 243.0 (Canada-121.5, 126.7 and 243.0) are available at many FSSs and are not shown. All other frequencies are shown. Certain FSSs provide Airport Advisory Service, see A/FD. Frequencies transmit and receive except those followed by R or T:
 R - Receive only
 T - Transmit only

CONTROLLED AIRSPACE

Controlled airspace consists of those areas where some or all aircraft are subjected to air traffic control within the following airspace classifications of A, B, C, D, & E.

Air Route Traffic Control Centers (ARTCC) are established to provide Air Traffic Control to aircraft operating on IFR flight plans within controlled airspace, particularly during the enroute phase of flight. Boundaries of the ARTCCs are shown in their entirety using the symbol below.



The responsible ARTCC Center names are shown adjacent and parallel to the boundary line.

ARTCC sector frequencies are shown in boxes outlined by the same symbol.



Class A Airspace is depicted as open area (white) on the IFR Enroute High Altitude Charts. It consists of airspace from 18,000 Mean Sea Level (MSL) to 60,000 MSL. In aviation terms those altitudes are written as FL 180 to FL 600, (18,000 MSL, is Flight Level (FL)180, 60,000 MSL, is FL 600.

Class B Airspace is depicted as screened blue area with a solid line encompassing the area.

Class C Airspace is depicted as screened blue area with a dashed line encompassing the area with a following the airport name.

Class B and Class C Airspace consist of controlled airspace extending upward from the surface or a designated floor to specified altitudes, within which all aircraft and pilots are subject to the operating rules and requirements specified in the Federal Aviation Regulations (FAR) 71. Class B and C Airspace are shown in abbreviated forms on IFR Enroute Low Altitude Charts. A general note adjacent to Class B airspace refers the user to the appropriate VFR Terminal Area Chart.

Class D Airspace (airports with an operating control tower) are depicted as open area (white) with a following the airport name.

Class E Airspace is depicted as open area (white) on the IFR Enroute Low Altitude Charts. It consists of airspace below FL180.

UNCONTROLLED AIRSPACE

Class G Airspace within the United States extends to 14,500' MSL. This uncontrolled airspace is shown as screened brown.

On Area Charts any uncontrolled airspace boundaries are depicted with a .012" brown line and a .060" screen brown band on the uncontrolled side, so as to be seen over the terrain.



SPECIAL USE AIRSPACE

Special Use Airspace (SUA) confines certain flight activities, restricts entry, or cautions other aircraft operating within specific boundaries. SUA areas are shown in their entirety, even when they overlap, adjoin, or when an area is designated within another area. SUA with altitudes from the surface and above are shown on the IFR Enroute Low Altitude Charts. Similarly, SUA that extends above 18,000' MSL are shown on IFR Enroute High Altitude Charts. On IFR Enroute Altitude Charts tabulations, identify the type of SUA, ID, effective altitudes, times of use, controlling agency and the panel it is located on.

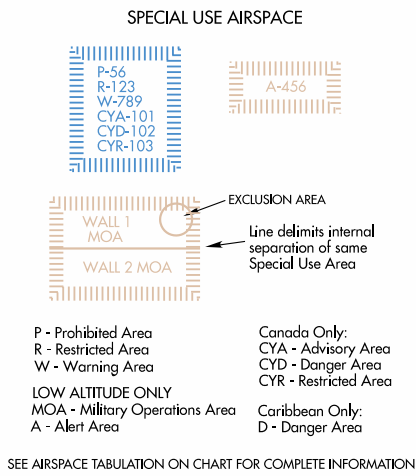

OTHER AIRSPACE

FAR 91 Special Air Traffic Rules are shown with the type NO SVFR above the airport name.

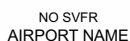

FAR 93 Special Airspace Traffic Rules are shown with a solid line box around the airport name, indicating

FAR 93 Special Requirements see Directory/Supplement.

Mode C Required Airspace (from the surface to 10,000' MSL) within 30 NM radius of the primary airport(s) for which a Class B airspace is designated, is depicted on IFR Enroute Low Altitude Charts as a blue circle labeled MODE C 30 NM.



Mode C is also required for operations within and above all Class C airspace up to 10,000' MSL, but not depicted. See FAR 91.215 and the AIM.

INSTRUMENT AIRWAYS

The FAA has established two fixed route systems for air navigation. The VOR and LF/MF system—designated from 1,200' Above Ground Level (AGL) to but not including FL 180—is shown on IFR Enroute Low Altitude Charts, and the Jet Route system—designated from FL 180 to FL 450 inclusive—is shown on IFR Enroute High Altitude Charts.

VOR LF/MF AIRWAY SYSTEM

(IFR LOW ALTITUDE Enroute CHARTS)

In this system VOR airways – airways based on VOR or VORTAC NAVAIDs – are depicted in black and identified by a “V” (Victor) followed by the route number (e.g., “V12”). In Alaska and Canada, some segments of low-altitude airways are based on LF/MF NAVAIDs and are charted in brown instead of black. Routes from a UHF facility to a LF/MF facility change from black to brown at the midpoint.

LF/MF airways – airways based on LF/MF NAVAIDs – are sometimes called “colored airways” because they are identified by color name and number (e.g., “Amber One”, charted as “A1”). In Alaska Green and Red airways are plotted east and west, and Amber and Blue airways are plotted north and south. Regardless of their color identifier, LF/MF airways are shown in brown in the contiguous U.S.

AIRWAY/ROUTE DATA

On both series of IFR Enroute Charts, airway/route data such as the airway identifications, magnetic courses bearings or radials, mileages, and altitudes (e.g., Minimum Enroute Altitude (MEA), Minimum Obstruction Clearance Altitude (MOCA), Maximum Authorized Altitude (MAA), are shown aligned with the airway. As a rule the airway/route data is charted and in the same color as the airway, with one exception. Charted in blue, Global Navigation Satellite System (GNSS) MEAs, identified with a “G” suffix, have been added to “V” and “colored airways” for aircraft flying those airways using Global Positioning System (GPS) navigation.

Airways/Routes predicated on VOR or VORTAC NAVAIDs are defined by the outbound radial from the NAVAID. Airways/Routes predicated on LF/MF NAVAIDs are defined by the inbound bearing.

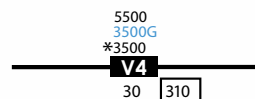

Victor Route (with RNAV/GPS MEA shown in blue)

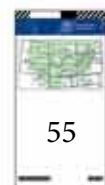



AREA NAVIGATION (RNAV) "T" ROUTE SYSTEM

The FAA has created new low altitude area navigation (RNAV) "T" routes for the enroute and terminal environments. The RNAV routes will provide more direct routing for IFR aircraft and enhance the safety and efficiency of the National Airspace System. To utilize these routes aircraft are required to be equipped with IFR approved GNSS. In Alaska, TSO-145a and 146a equipment is required.

Low altitude RNAV only routes are identified by the prefix "T", and the prefix "TK" for RNAV helicopter routes followed by a three digit number (T-200 to T-500). Routes are depicted in blue on the IFR Enroute Low Altitude Charts. RNAV route data (route line, identification boxes, mileages, waypoints, waypoint names, magnetic reference courses and MEAs) will also be printed in blue. Magnetic reference courses will be shown originating from a waypoint, fix/reporting point or NAVAID. GNSS MEA for each segment is established to ensure obstacle clearance and communications reception. GNSS MEAs are identified with a "G" suffix.



Joint Victor/RNAV routes are charted as outlined above except as noted. The joint Victor route and the RNAV route identification boxes are shown adjacent to each other. Magnetic reference courses are not shown. MEAs are charted above the appropriate identification box or stacked in pairs, GNSS and Victor. On joint routes, RNAV specific information will be printed in blue.

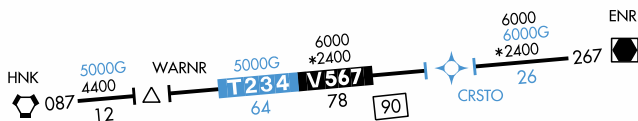

OFF ROUTE OBSTRUCTION CLEARANCE ALTITUDE (OROCA)

The Off Route Obstruction Clearance Altitude (OROCA) is depicted on IFR Enroute Low Altitude and Pacific charts and is represented in thousands and hundreds of feet above MSL. OROCA's are shown in every 30 x 30 minute quadrant on Area Charts, every one degree by one degree quadrant for IFR Enroute Low Altitude Charts - U.S. and every two degree by two degree quadrant on IFR Enroute Low Altitude Charts - Alaska. The OROCA represents the highest possible obstruction elevation including both terrain and other vertical obstruction data (towers, trees, etc.) bounded by the ticked lines of latitude/longitude

including data 4 NM outside the quadrant. In this example the OROCA represents 12,500 feet.

OROCA is computed just as the Maximum Elevation Figure (MEF) found on Visual Flight Rule (VFR) Charts except that it provides an additional vertical buffer of 1,000 feet in designated non-mountainous areas and a 2,000 foot vertical buffer in designated mountainous areas within the United States. For areas in Mexico and the Caribbean, located outside the U.S. Air Defense Identification Zone (ADIZ), the OROCA provides obstruction clearance with a 3,000 foot vertical buffer. Evaluating the area around the quadrant provides the chart user the same lateral clearance an airway provides should the line of intended flight follow a ticked line of latitude or longitude. OROCA does not provide for NAVAID signal coverage, communication coverage and would not be consistent with altitudes assigned by Air Traffic Control. OROCA's can be found over all land masses and open water areas containing man-made obstructions (such as oil rigs).

12⁵

MILITARY TRAINING ROUTES (MTRs)

Military Training Routes (MTRs) are routes established for the conduct of low-altitude, high-speed military flight training (generally below 10,000 feet MSL at airspeeds in excess of 250 knots Indicated Air Speed). These routes are depicted in brown on IFR Enroute Low Altitude Charts, and are not shown on inset charts or on IFR Enroute High Altitude Charts. IFR Enroute Low Altitude Charts depict all IFR Military Training Routes (IRs) and VFR Military Training Routes (VRs), except those VRs that are entirely at or below 1,500 feet AGL.

MTRs are identified by designators (IR-107, VR-134) which are shown in brown on the route centerline. Arrows are shown to indicate the direction of flight along the route. The width of the route determines the width of the line that is plotted on the chart: Route segments with a width of 5 NM or less, both sides of the centerline, are shown by a .02" line.



Route segments with a width greater than 5 NM, either or both sides of the centerline, are shown by a .035" line.

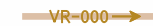

MTRs for particular chart pairs (ex. L1/2, etc.) are alphabetically, then numerically tabulated. The tabulation includes MTR type and unique identification and altitude range.

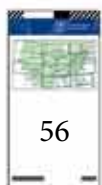



JET ROUTE SYSTEM (HIGH ALTITUDE ENROUTE CHARTS)

Jet routes are based on VOR or VORTAC NAVAIDs, and are depicted in black with a "J" identifier followed by the route number (e.g., "J12"). In Alaska, Russia and Canada some segments of jet routes are based on LF/MF NAVAIDs and are shown in brown instead of black. Routes from a UHF facility to a LF/MF facility change from black to brown at the midpoint.

AREA NAVIGATION (RNAV) "Q" ROUTE SYSTEM (IFR Enroute HIGH ALTITUDE CHARTS)

The FAA has adopted certain amendments to Title 14, Code of Federal Regulations which paved the way for the development of new area high altitude navigation (RNAV) "Q" routes in the U.S. National Airspace System (NAS). These amendments enable the FAA to take advantage of technological advancements in navigation systems such as the GPS. RNAV "Q" Route MEAs are shown when other than FL 180 MEAs for DME/DME/ Inertial Reference Unit (IRU) RNAV aircraft have a "D" suffix.

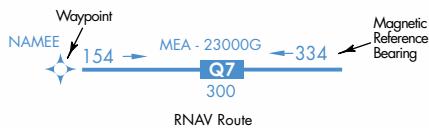

RNAV routes and associated data are charted in blue.

"Q" Routes on the IFR Gulf of Mexico charts are shown in black. Magnetic referencing courses are shown originating from a waypoint, fix/reporting point, or NAVAID. Joint Jet/RNAV route identification boxes will be located adjacent to each other with the route charted in black. With the exception of Q-Routes in the Gulf of Mexico, GNSS or DME/DME/IRU RNAV are required, unless otherwise indicated. DME/DME/IRU RNAV aircraft should refer to the A/FD or appropriate Supplement for DME information. Altitude values are stacked highest to lowest.

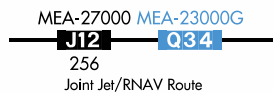

TERRAIN CONTOURS ON AREA CHARTS

Based on a recommendation of the National Transportation Safety Board, terrain contours have been added to the Enroute Area Charts and are intended to increase pilots' situational awareness for safe flight over changes in terrain. The following Area Charts portray terrain: Anchorage, Denver, Fairbanks, Juneau, Los Angeles, Nome, Phoenix, San Francisco, Vancouver and Washington.

When terrain rises at least a 1,000 feet above the primary airports' elevation, terrain is charted using shades of brown with brown contour lines and values. The initial contour will be 1,000 or 2,000 feet above the airports' elevation. Subsequent intervals will be 2,000 or 3,000 foot increments.

Contours are supplemented with a representative number of spots elevations and are shown in solid black. The highest elevation on an Area Chart is shown with a larger spot and text.

The following boxed note is added to the affected Area Charts:

NOTE: TERRAIN CONTOURS HAVE BEEN ADDED TO THOSE AREA CHARTS WHERE THE TERRAIN ON THE CHART IS 1000 FOOT OR GREATER THAN THE ELEVATION OF THE PRIMARY AIRPORT

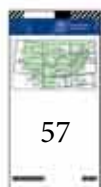



IFR AERONAUTICAL CHART SYMBOLS

IFR ENROUTE LOW/HIGH ALTITUDE (U.S., PACIFIC AND ALASKA CHARTS)

- AIRPORTS.....59
- RADIO AIDS TO NAVIGATION.....60
- AIRSPACE INFORMATION.....61
- NAVIGATIONAL AND PROCEDURAL INFORMATION.....66
- CULTURE.....67
- HYDROGRAPHY.....67
- TOPOGRAPHY.....67

OCEANIC ROUTE PLANNING CHARTS, NORTH ATLANTIC, WATRS AND NORTH PACIFIC ROUTE CHARTS

- AIRPORTS.....68
- RADIO AIDS TO NAVIGATION.....68
- AIRSPACE INFORMATION.....69
- NAVIGATIONAL AND PROCEDURAL INFORMATION.....69
- CULTURAL BOUNDARIES.....70
- HYDROGRAPHY.....70





IFR ENROUTE LOW/HIGH ALTITUDE U.S., PACIFIC AND ALASKA CHARTS

AIRPORTS

AIRPORT DATA

LOW/HIGH ALTITUDE

Facilities in BLUE or GREEN have an approved Instrument Approach Procedure and/or RADAR MINIMA published in either the FAA Terminal Procedures Publications or the DoD FLIPs. Those in BLUE have an Instrument Approach Procedure and/or RADAR MINIMA published at least in the High Altitude DoD FLIPs. Facilities in BROWN do not have a published Instrument Approach Procedure or RADAR MINIMA.

All IAP Airports are shown on the Low Altitude Charts.

Non-IAP Airports shown on the U.S. Low Altitude Charts have a minimum hard surface runway of 3000'.

Non-IAP Airports shown on the Alaska Low Altitude Charts have a minimum hard or soft surface runway of 3000'.

Airports shown on the U.S. High Altitude Charts have a minimum hard surface runway of 5000'.

Airports shown on the Alaska High Altitude Charts have a minimum hard or soft surface runway of 4000'.

Associated city names for public airports are shown above or preceding the airport name. If airport name and city name are the same, only the airport name is shown. City names for military and private airports are not shown.

The airport identifier in parentheses follows the airport name or Pvt.

Airport symbol may be offset for enroute navigational aids.

Pvt - Private Use

AIRPORTS

CIVIL

LOW/ HIGH ALTITUDE



CIVIL AND MILITARY

LOW/ HIGH ALTITUDE



MILITARY

LOW/ HIGH ALTITUDE



SEAPLANE - CIVIL

LOW ALTITUDE



HELIPORT

LOW ALTITUDE



AIRPORT DATA DEPICTION

LOW ALTITUDE - U.S. & ALASKA

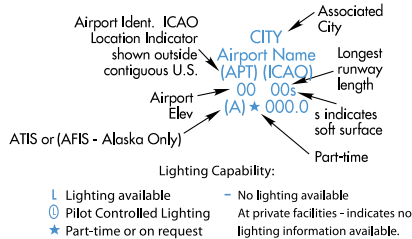

For complete information consult the Airport/Facility Directory.

1. Airport elevation given in feet above or below mean sea level
2. Pvt - Private use, not available to general public.
3. A solid line box enclosing the airport name indicates FAR 93 Special Requirements- see Directory/Supplement
4. "NO SVFR" above the airport name indicates FAR 91 fixed-wing special VFR flight is prohibited
5. [C] or [D] following the airport identifier indicates Class C or Class D Airspace.
6. Airport symbol may be offset for enroute navigational aids.
7. Associated city names for public airports are shown above or preceding the airport name. If airport name and city name are the same, only the airport name is shown. The airport identifier in parentheses follows the airport name. City names for military and private airports are not shown.
8. Airport Ident ICAO Location Indicator shown outside contiguous U.S.
9. AFIS Alaska only

HIGH ALTITUDE - U.S.



HIGH ALTITUDE - ALASKA

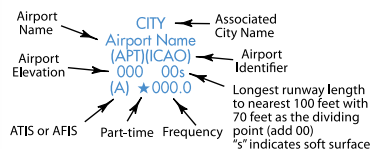

EMERGENCY USE ONLY

PACIFIC ONLY





IFR ENROUTE LOW/HIGH ALTITUDE U.S., PACIFIC AND ALASKA CHARTS

RADIO AIDS TO NAVIGATION

VHF OMNIDIRECTIONAL RADIO RANGE (VOR)

LOW/ HIGH ALTITUDE

VHF / UHF Data is depicted in Black
LF / MF Data is depicted in Brown



COMPASS ROSES are oriented to Magnetic North of the NAVAID which may not be adjusted to the charted isogonic values.

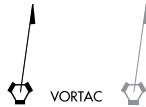

VORTAC

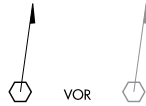

VOR

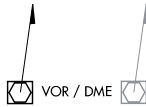

VOR / DME

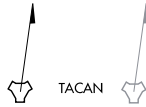

TACAN

HIGH ONLY

(L) Frequency Protection usable range at 18,000' AGL - 40NM

(T) Frequency Protection usable range at 12,000' AGL - 25NM

"L" and "T" category NAVAIDS located off Jet Routes are depicted in screen black. NAVAIDS without classification are "H" category.

DISTANCE MEASURING EQUIPMENT (DME)

TACTICAL AIR NAVIGATION (TACAN)

NON-DIRECTIONAL RADIOBEACON (NDB)

MARINE RADIOBEACON (RBN)

LOW/ HIGH ALTITUDE



NDB or RBN with Magnetic North Indicator



NDB with DME

COMPASS LOCATOR BEACON

LOW ALTITUDE



ILS LOCALIZER

LOW ALTITUDE



ILS Localizer Course with additional navigation function.

RADIO AIDS TO NAVIGATION

VOR/DME RNAV WAYPOINT DATA

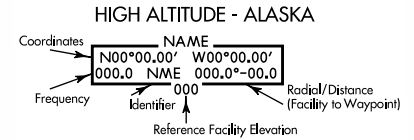

NAVIGATION AND COMMUNICATION BOXES

LOW/ HIGH ALTITUDE



VOR with TACAN compatible DME

Underline indicates No Voice Transmitted on this frequency

TACAN channels are without voice but not underlined

Crosshatch indicates Shutdown Status

(T) Frequency Protection - usable range 25 NM at 12000' AGL

(Y) TACAN must be placed in "Y" mode to receive distance information

(A) ASOS/AWOS - Automated Surface Observing Station/Automated Weather Observing Station

(H) HIWAS - Hazardous Inflight Weather Advisory Service

(T) TWEB - Transcribed Weather Broadcast (Alaska only)

Automated weather, when available, is broadcast on the associated NAVAID frequency.



Part-time or On-Request

NDB with DME

DME channel and paired VHF frequency are shown



IFR ENROUTE LOW/HIGH ALTITUDE U.S., PACIFIC AND ALASKA CHARTS

RADIO AIDS TO NAVIGATION

NAVIGATION AND COMMUNICATION BOXES (CONTINUED)

122.65
WICHITA
 113.8 ICT 85
 N37° 44.70' W97° 35.03'

FSS associated with a NAVAID

123.6 122.65
EL DORADO ELD

Name and identifier of FSS not associated with NAVAID

Shadow NAVAID Boxes indicate Flight Service Station (FSS) locations. Frequencies 122.2, 255.4 and emergency 121.5 and 243.0 are available at many FSSs and are not shown. All other frequencies are shown above the box.

Certain FSSs provide Local Airport Advisory (LAA) on 123.6.

Frequencies transmit and receive except those followed by R or T: R - Receive only T - Transmit only

In Canada, shadow boxes indicate FSSs with standard group frequencies of 121.5, 126.7 and 243.0.

122.55
JONESBORO

Remote Communications Outlet (RCO) FSS name and remoted frequency are shown

122.6
PINE BLUFF
 116.0 PBF 107
 N34° 14.81' W91° 55.57'

Controlling FSS Name

Thin Line NAVAID Boxes without frequencies and controlling FSS name indicate no FSS frequencies available. Frequencies positioned above thin line boxes are remoted to the NAVAID sites. Other frequencies at the controlling FSS named are available, however, altitude and terrain may determine their reception.

Morse Code is not shown in NAVAID boxes on High Altitude Charts.

- Flight Service Station (FSS), Remote Communications Outlet (RCO) or Automated Weather Observing Station (AWOS/ASOS) not associated with a charted NAVAID or airport.

NAME ASOS 000.0 Stand Alone ASOS/AWOS

AIRSPACE INFORMATION

LOW ALTITUDE AIRWAYS

LOW/HIGH ALTITUDE

VHF / UHF Data is depicted in Black
LF / MF Data is depicted in Brown
RNAV Route data is depicted in Blue

- VOR Airway/Victor Route
- LF/MF Airway
- Uncontrolled LF/MF Airway
- Oceanic Route
- ATS Route
- RNAV Route GNSS required
- RNAV Helicopter Route GNSS required

HIGH ALTITUDE ROUTES

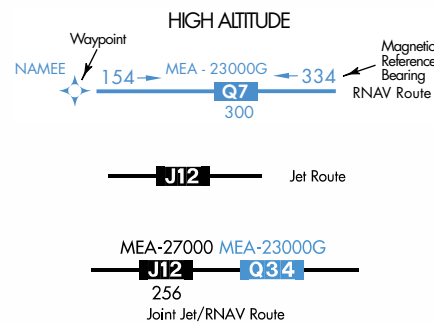

SINGLE DIRECTION ROUTES

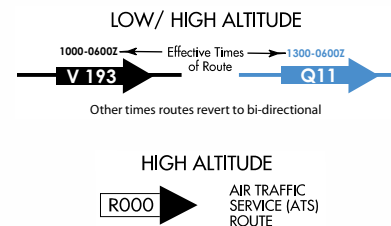

DIRECTION OF FLIGHT INDICATOR

LOW ALTITUDE - CANADA
← EVEN

SUBSTITUTE ROUTE

LOW/ HIGH ALTITUDE

All relative and supporting data shown in brown
See NOTAMs or appropriate publication for specific information

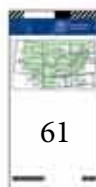



IFR ENROUTE LOW/HIGH ALTITUDE U.S., PACIFIC AND ALASKA CHARTS

AIRSPACE INFORMATION

UNUSABLE ROUTE

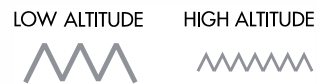

BY-PASS ROUTE

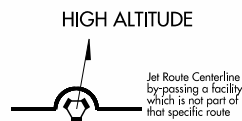

AIRWAY RESTRICTION

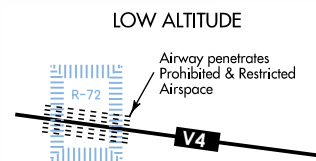

MILITARY TRAINING ROUTES (MTR)

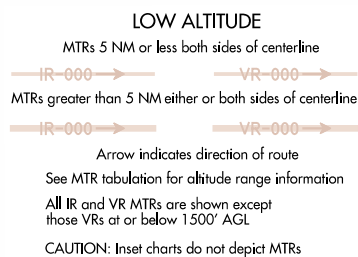

FIXES/ATC REPORTING REQUIREMENTS

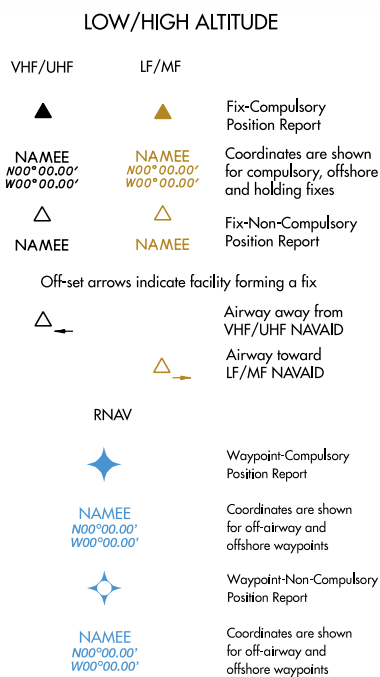

AIRSPACE INFORMATION

FIXES/ATC REPORTING REQUIREMENTS (CONTINUED)

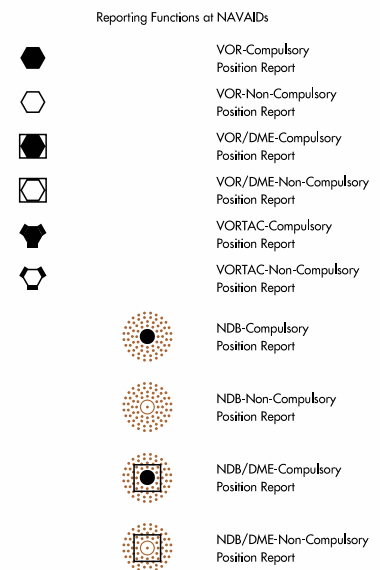

RADIALS AND BEARINGS

All radials and bearings are magnetic

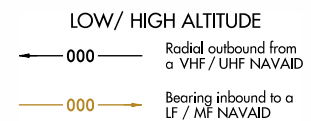

FACILITY LOCATORS

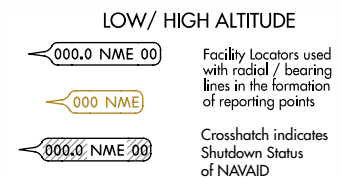

MILEAGES

All Mileages are Nautical (NM)

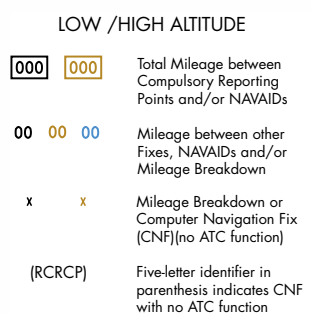

DISTANCE MEASURING EQUIPMENT (DME) FIX

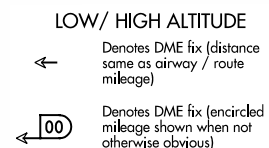



IFR ENROUTE LOW/HIGH ALTITUDE U.S., PACIFIC AND ALASKA CHARTS

AIRSPACE INFORMATION

MINIMUM ENROUTE ALTITUDE (MEA)

All Altitudes Are MSL Unless Otherwise Noted

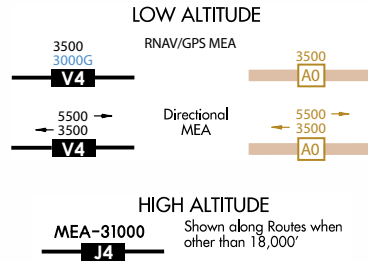

MINIMUM ENROUTE ALTITUDE (MEA) GAP

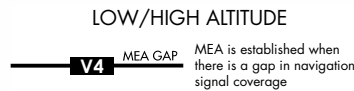

MAXIMUM AUTHORIZED ALTITUDE (MAA)

All Altitudes Are MSL Unless Otherwise Noted

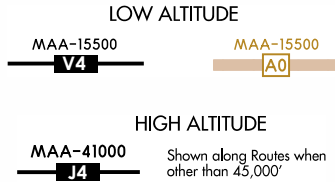

MINIMUM OBSTRUCTION CLEARANCE ALTITUDE (MOCA)

All Altitudes Are MSL Unless Otherwise Noted

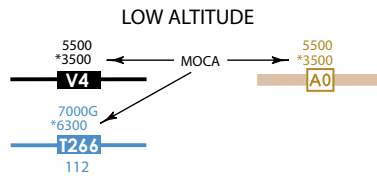

CHANGEOVER POINT

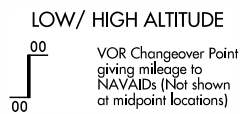

ALTITUDE CHANGE

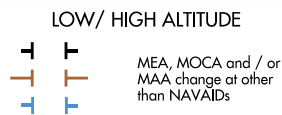

MINIMUM CROSSING ALTITUDE (MCA)

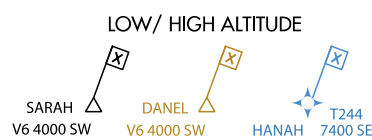

MINIMUM RECEPTION ALTITUDE (MRA)



AIRSPACE INFORMATION

HOLDING PATTERNS

RNAV Holding Pattern
Magnetic Reference Bearing is determined by the isogonic value at the waypoint or fix.

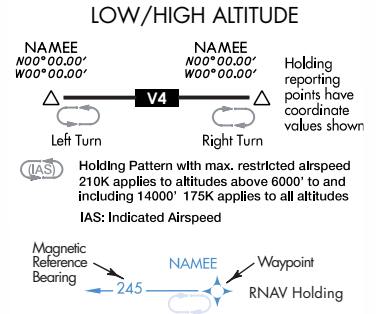

AIR DEFENSE IDENTIFICATION ZONE (ADIZ)

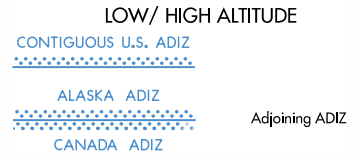

AIR ROUTE TRAFFIC CONTROL CENTER (ARTCC)

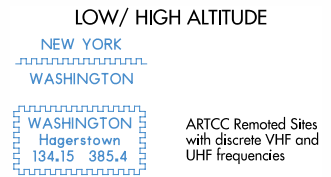

AIR TRAFFIC SERVICE IDENTIFICATION DATA

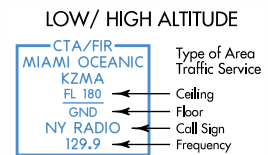

ALTIMETER SETTING CHANGE



FLIGHT INFORMATION REGIONS (FIR)

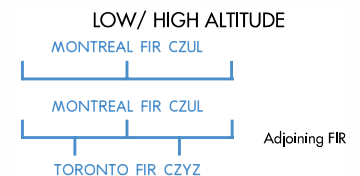

CONTROL AREAS (CTA)

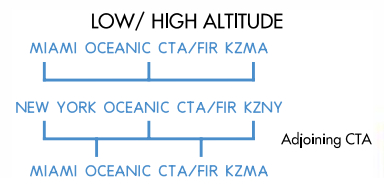



IFR ENROUTE LOW/HIGH ALTITUDE U.S., PACIFIC AND ALASKA CHARTS

AIRSPACE INFORMATION

UPPER INFORMATION REGIONS (UIR)

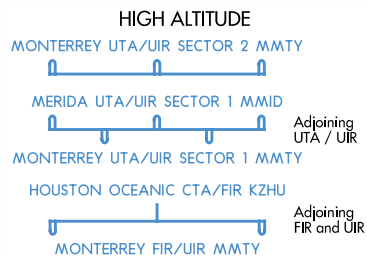

UPPER CONTROL AREAS (UTA)

ADDITIONAL CONTROL AREAS

LOW ALTITUDE CONTROL 1234L

HIGH ALTITUDE CONTROL 1234H

OFF ROUTE OBSTRUCTION CLEARANCE ALTITUDE (OROCA)

LOW ALTITUDE
12⁵
Example: 12,500 feet

OROCA is computed similarly to the Maximum Elevation Figure (MEF) found on Visual charts except that it provides an additional vertical buffer of 1,000 feet in designated non-mountainous areas and a 2,000 foot vertical buffer in designated mountainous areas within the United States.

AIRSPACE INFORMATION

SPECIAL USE AIRSPACE

LOW/HIGH ALTITUDE

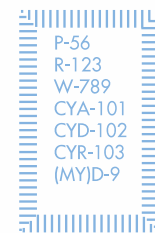

- P - Prohibited Area
- R - Restricted Area
- W - Warning area
- Canada Only
- CYA - Advisory Area
- CYD - Danger Area
- CYR - Restricted Area
- Caribbean Only
- D - Danger Area

In the Caribbean the first two letters represent the country code, i.e. (MY) Bahamas, (MU) Cuba.

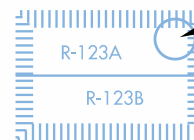

- EXCLUSION AREA
- Line delimits internal separation of same Special Use Area

LOW ALTITUDE



- A - Alert Area
- MOA - Military Operation Area

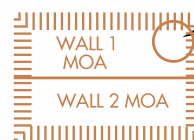

- EXCLUSION AREA
- Line delimits internal separation of same Special Use Area

SEE AIRSPACE TABULATION ON EACH CHART FOR COMPLETE INFORMATION ON :

- AREA IDENTIFICATION
- EFFECTIVE ALTITUDES
- OPERATING TIMES
- CONTROLLING AGENCY A/G CALL PANEL





IFR ENROUTE LOW/HIGH ALTITUDE U.S., PACIFIC AND ALASKA CHARTS

AIRSPACE INFORMATION

CONTROLLED AIRSPACE

HIGH ALTITUDE

CLASS A AIRSPACE

Open Area (White)

That airspace from 18,000' MSL to and including FL 600, including the airspace overlying the waters within 12 NM of the coast of the contiguous United States and Alaska and designated offshore areas, excluding Santa Barbara Island, Farallon Island, the airspace south of latitude 25°04'00"N, the Alaska peninsula west of longitude 160°00'00"W, and the airspace less than 1,500' AGL.

That airspace from 18,000' MSL to and including FL 450, including Santa Barbara Island, Farallon Island, the Alaska peninsula west of longitude 160°00'00"W, and designated offshore areas.

LOW ALTITUDE

CLASS B AIRSPACE

Screened Blue with a Solid Blue Outline

That airspace from the surface to 10,000' MSL (unless otherwise designated) surrounding the nation's busiest airports. Each Class B airspace area is individually tailored and consists of a surface area and two or more layers.

MODE C AREA

A Solid Blue Outline

That airspace within 30 NM of the primary airports of Class B airspace and within 10 NM of designated airports. Mode-C transponder equipment is required. (see FAR 91.215)

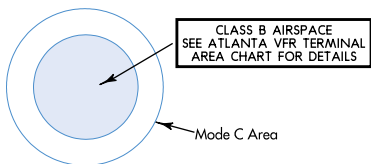

LOW ALTITUDE

CLASS C AIRSPACE

Screened Blue with a Solid Blue Dashed Outline

That airspace from the surface to 4,000' (unless otherwise designated) above the elevation of selected airports (charted in MSL). The normal radius of the outer limits of Class C airspace is 10 NM. Class C airspace is also indicated by the letter C in a box following the airport name.



LOW ALTITUDE

CLASS D AIRSPACE

Open Area (White)

That airspace, from the surface to 2,500' (unless otherwise designated) above the airport elevation (charted in MSL), surrounding those airports that have an operational control tower. Class D airspace is indicated by the letter D in a box following the airport name.

AIRSPACE INFORMATION

CONTROLLED AIRSPACE

LOW ALTITUDE

CLASS E AIRSPACE

Open Area (White)

That controlled airspace below 14,500' MSL which is not Class B, C, or D.

Federal airways from 1,200' AGL to but not including 18,000' MSL (unless otherwise specified).

Other designated control areas below 14,500' MSL. Not Charted

That airspace from 14,500' MSL to but not including 18,000' MSL, including the airspace overlying the waters within 12 NM of the coast of the contiguous United States and Alaska and designated offshore areas, excluding the Alaska peninsula west of longitude 160°00'00"W and the airspace less than 1,500' AGL.

CONTROLLED AIRSPACE

Canada Only

LOW ALTITUDE

CLASS B AIRSPACE

Screened Brown Checkered Area

Controlled airspace above 12,500' MSL

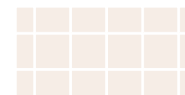

UNCONTROLLED AIRSPACE

LOW/ HIGH ALTITUDE

CLASS G AIRSPACE

Screened Brown Area

Low Altitude

That portion of the airspace below 14,500' MSL that has not been designated as Class B, C, D or E airspace.

High Altitude

That portion of the airspace from 18,000' MSL and above that has not been designated as Class A airspace.

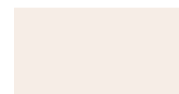

CANADIAN AIRSPACE

Appropriate notes as required may be shown.

LOW/HIGH ALTITUDE

AIRSPACE CLASSIFICATION (SEE CANADA FLIGHT SUPPLEMENT) AND OPERATIONAL REQUIREMENTS (DOD USERS SEE DOD AREA PLANNING AP/1) MAY DIFFER BETWEEN CANADA AND THE UNITED STATES

NOTE: REFER TO CURRENT CANADIAN CHARTS AND FLIGHT INFORMATION PUBLICATIONS FOR INFORMATION WITHIN CANADIAN AIRSPACE

AIRSPACE OUTSIDE OF U.S.

Other than Canada

Appropriate notes as required may be shown.

DOD USERS REFER TO CURRENT DOD (INGA) CHARTS AND FLIGHT INFORMATION PUBLICATIONS FOR INFORMATION OUTSIDE OF U.S. AIRSPACE

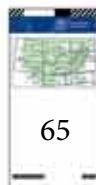



IFR ENROUTE LOW/HIGH ALTITUDE U.S., PACIFIC AND ALASKA CHARTS

NAVIGATIONAL AND PROCEDURAL INFORMATION

ISOGONIC LINE AND VALUE

LOW/ HIGH ALTITUDE

—B°W—
Isogonic lines and values shall be based on the five year epoch.

TIME ZONE

LOW/ HIGH ALTITUDE

Central Std +6=UTC Eastern Std +5=UTC

‡ During periods of Daylight Saving Time (DT), effective hours will be one hour earlier than shown. All states observe DT except Arizona and Hawaii.

ALL TIME IS COORDINATED UNIVERSAL TIME (UTC)

ENLARGEMENT AREA

LOW/ HIGH ALTITUDE

JACKSONVILLE
AREA CHART A-1

MATCH MARK

LOW/HIGH ALTITUDE



NOTES

LOW/ HIGH ALTITUDE

FAA AIR TRAFFIC SERVICE OUTSIDE U.S. AIRSPACE IS PROVIDED IN ACCORDANCE WITH ARTICLE 12 AND ANNEX 11 OF ICAO CONVENTION. ICAO CONVENTION NOT APPLICABLE TO STATE AIRCRAFT BUT COMPLIANCE WITH ICAO STANDARDS AND PRACTICES IS ENCOURAGED.

CAUTION: POSSIBLE DAMAGE AND/OR INTERFERENCE TO AIRBORNE RADIO DUE TO HIGH LEVEL RADIO ENERGY IN THE VICINITY OF R-2206

CAUTION: ACCURACY OF AIR TRAFFIC SERVICES RELATIVE TO HAVANA FIR CANNOT BE CONFIRMED. CONSULT NOTAMS.

North American Datum of 1983 (NAD 83), for charting purposes is considered equivalent to World Geodetic System 1984 (WGS 84).

MORSE CODE

LOW/ HIGH ALTITUDE

A	--	N	--	1	-----
B	----	O	----	2	-----
C	-----	P	-----	3	-----
D	----	Q	-----	4	-----
E	-	R	----	5	-----
F	-----	S	---	6	-----
G	----	T	-	7	-----
H	----	U	---	8	-----
I	--	V	-----	9	-----
J	-----	W	----	0	-----
K	----	X	-----		
L	-----	Y	-----		
M	---	Z	-----		

NAVIGATIONAL AND PROCEDURAL INFORMATION

CRUISING ALTITUDES

U.S. only

LOW ALTITUDE

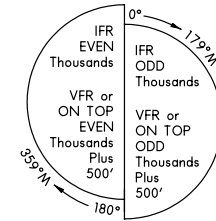

VFR above 3000' AGL unless otherwise authorized by ATC

IFR outside controlled airspace

IFR within controlled airspace as assigned by ATC

All courses are magnetic

HIGH ALTITUDE

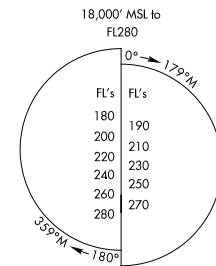

VFR or VFR On Top add 500'

No VFR flights within Class A Airspace above 3000' AGL unless otherwise authorized by ATC.

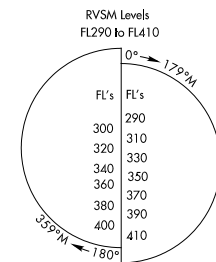

No VFR or VFR On Top authorized above FL285 in RVSM airspace.

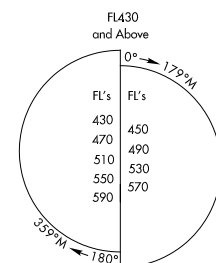

IFR within controlled airspace as assigned by ATC
All courses are magnetic





IFR ENROUTE LOW/HIGH ALTITUDE U.S., PACIFIC AND ALASKA CHARTS

CULTURE

BOUNDARIES

International

LOW/ HIGH ALTITUDE



*U.S./Russia
Maritime Line*

LOW/ HIGH ALTITUDE



Date Line

LOW/ HIGH ALTITUDE



HYDROGRAPHY

SHORELINE

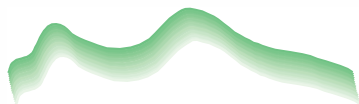

TOPOGRAPHY

TERRAIN

Area Charts

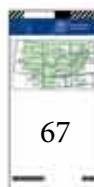
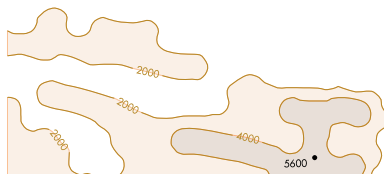



OCEANIC ROUTE PLANNING CHARTS

AIRPORTS

AIRPORT DATA

Airport of Entry (AOE) are shown with four letter ICAO Identifier

LANDPLANE-CIVIL

Refueling and repair facilities for normal traffic.



LANDPLANE-CIVIL AND MILITARY

Refueling and repair facilities for normal traffic.



LANDPLANE-MILITARY

Refueling and repair facilities for normal traffic.



RADIO AIDS TO NAVIGATION

VHF OMNIDIRECTIONAL RADIO RANGE (VOR)



DISTANCE MEASURING EQUIPMENT (DME)



VOR TACAN (VORTAC)



TACTICAL AIR NAVIGATION (TACAN)



NON-DIRECTIONAL RADIOBEACON (NDB)



DISTANCE MEASURING EQUIPMENT (DME)



IDENTIFICATION BOX

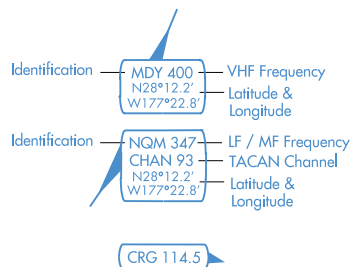

AIRSPACE INFORMATION

AIR TRAFFIC SERVICE (ATS) / OCEANIC ROUTES

Note: Mileages are Nautical (NM)

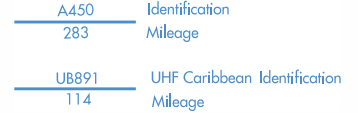

ATS SINGLE DIRECTION ROUTE



AERIAL REFUELING TRACKS



AIR DEFENSE IDENTIFICATION ZONE (ADIZ)



AIR ROUTE TRAFFIC CONTROL CENTER (ARTCC)



FLIGHT INFORMATION REGIONS (FIR) AND/OR (CTA)



UPPER INFORMATION REGIONS (UIR)



UPPER CONTROL AREAS (UTA)



OCEANIC CONTROL AREAS (OCA) AND/OR (CTA/FIR)

CONTROL 1485

ADDITIONAL OCEANIC CONTROL AREAS

Note: Limits not shown when coincident with Warning Areas.



OCEANIC ROUTE PLANNING CHARTS

AIRSPACE INFORMATION

BUFFER ZONE



Teeth point to area

NON-FREE FLYING ZONE



Teeth point to area

NORTH ATLANTIC/MINIMUM NAVIGATION PERFORMANCE SPECIFICATIONS (NAT/MNPS)



NAT MNPS (FL 285-FL420)

FIXES/ATC REPORTING REQUIREMENTS

In congested areas select fixes have coordinates, use, compl/noncompl tabulated.

Name	— ARTOP	▲	Compulsory
Latitude & Longitude	— N20°52.7' W80°00.0'	△	Non-Compulsory
NAMEE	N00°00.00' W00°00.00'	◆	Waypoint-Compulsory Position Report
			Coordinates are shown for off-airway and offshore waypoints
NAMEE	N00°00.00' W00°00.00'	◆	Waypoint-Non-Compulsory Position Report
			Coordinates are shown for off-airway and offshore waypoints

SPECIAL USE AIRSPACE

Warning Area



12 Mile Limit



UNCONTROLLED AIRSPACE



NAVIGATIONAL AND PROCEDURAL INFORMATION

MILEAGE CIRCLES

Note: Mileages are Nautical (NM)



TIME ZONE

Note: All time is Coordinated Universal (Standard) Time (UTC)

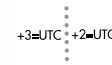

OVERLAP MARKS

North Pacific Route Chart (NPRC) Only

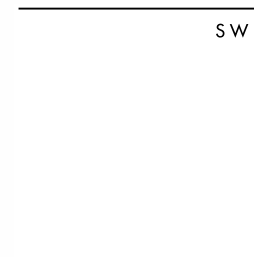

COMPASS ROSE

Note: Compass Roses oriented to Magnetic North

NPRC Only

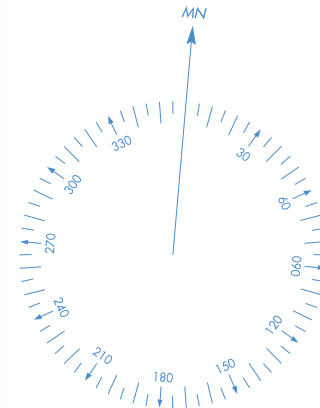

NOTES

Warning



NPRC Only





OCEANIC ROUTE PLANNING CHARTS

CULTURAL BOUNDARIES

INTERNATIONAL



MARITIME

NPRC Only



DATE LINE

NPRC Only



HYDROGRAPHY

SHORELINES



IKARIA





U.S. TERMINAL PROCEDURES PUBLICATION

The U.S. Terminal Procedure Publications include the Standard Instrument Approach Procedures (SIAPS), Standard Instrument Departure Procedures (SIDs), Standard Terminal Arrivals (STARs), IFR Takeoff Minimums and (Obstacle) Departure Procedures (ODPs), IFR Alternate Minimums, and Radar Instrument Approach Minimums for use by civil and military aviation.

EXPLANATION OF TPP TERMS AND SYMBOLS

The discussions and examples in this section will be based primarily on the IFR (Instrument Flight Rule) Terminal Procedures Publication (TPP). Other IFR products use similar symbols in various colors (see Section 2 of this guide). The publication legends list aeronautical symbols with a brief description of what each symbol depicts. This section will provide a more detailed discussion of some of the symbols and how they are used on TPP charts.

FAA charts are prepared in accordance with specifications of the Interagency Air Cartographic Committee (IACC), which are approved by representatives of the Federal Aviation Administration, and the Department of Defense. Some information on these charts may only apply to military pilots.

PILOT BRIEFING INFORMATION

The pilot briefing information format consists of three horizontal rows of boxed procedure-specific information along the top edge

QUINHAGAK, ALASKA		AL-10363 (FAA)	10266
WAA5 CH 99311 W12A	APP CRS 120°	Rwy Idg TDZE Apt Elev 4200 42 42	RNAV (GPS) RWY 12 QUINHAGAK (AQH) (PAQH)
Procedure NA at night. Baro-VNAV NA. DME/DME RNP-0.3 NA. Use Platinum altimeter setting.		MISSED APPROACH: Climb to 4500 direct VIVUC and via 087° track to HUBUK and hold, continue dimb-in-hold to 4500.	
PLATINUM AWOS-3 118.375		BETHEL RADIO 122.1	UNICOM 122.8 (CTAF)

of the chart. Frequencies and channel, course and elevation values are charted in bold type. The top row contains the primary procedure navigation information, final approach course, landing distance available, touchdown zone, threshold and airport elevations. The middle row contains procedure notes and limitations, icons indicating if nonstandard alternate and/or takeoff minimums apply, approach lighting symbology, and the full text description of the missed approach procedure. The bottom row contains air to ground communication facilities and frequencies in the order in which they are used during an approach with the tower frequency box bolded.

When appears in the Notes section, it signifies the airport has IFR takeoff minimums and/or Departure Procedures published in Section L of the TPP.

CIVIL USERS NOTE: FAR 91 prescribes standard takeoff rules and establishes takeoff minimums for certain operators as follows: (1) Aircraft having two engines or less - one statute mile. (2) Aircraft having more than two engines - one-half statute mile. These standard minima apply in the absence of any different minima listed in Section L of the TPP.

ALL USERS: Airports that have Departure Procedures (DPs) designed specifically to assist pilots in avoiding obstacles during the climb to the minimum enroute altitude, and/or airports that have civil IFR takeoff minimums other than standard, are listed in Section L of the TPP by city. Takeoff Minimums and Departure Procedures apply to all runways unless otherwise

specified. Altitudes, unless otherwise indicated, are minimum altitudes in MSL.

DPs specifically designed for obstacle avoidance may be described in Section L of the TPP in text or published as a graphic procedure. Its name will be listed, and it can be found in either the TPPs (civil) or a separate Departure Procedure volume (military), as appropriate. Users will recognize graphic obstacle DPs by the word “(OBSTACLE)” included in the procedure title; e.g., TETON TWO (OBSTACLE). If not specifically assigned a departure procedure (i.e., ODP, SID, or radar vector) as part of an IFR clearance, an ODP may be required to be flown for obstacle clearance, even though not specifically stated in the IFR clearance. When doing so in this manner, ATC should be informed when the ODP being used contains a specified route to be flown, restrictions before turning, and/or altitude restrictions.

Graphic DPs designed by ATC to standardize traffic flows, ensure aircraft separation and enhance capacity are referred to as “Standard Instrument Departures (SIDs).” SIDs also provide obstacle clearance and are published under the appropriate airport section. ATC clearance must be received prior to flying a SID.

NOTE: Graphic Departure Procedures that have been designed primarily to assist Air Traffic Control in providing air traffic separation (as well as providing obstacle clearance) are usually assigned by name in an ATC clearance and are not listed by name in Section L of the TPP.

When appears in the Notes section of the approach chart, it indicates non-standard IFR alternate minimums exist for the airport. When an alternate airport is required, standard IFR alternate minimums apply. Precision approach procedures require a 600’ ceiling and 2 statute miles visibility; nonprecision approaches require an 800’ ceiling and 2 statute miles visibility. This information is found in Section M of the TPP. If appears, alternate minimums are not authorized due to unmonitored facility or absence of weather reporting service. Civil pilots see FAR 91.



The **W** symbol indicates that outages of the WAAS vertical guidance may occur daily at this location due to initial system limitations. WAAS NOTAMs for vertical outages are not provided for this approach. Use LNAV minima for flight planning at these locations, whether as a destination or alternate. For flight operations at these locations, when the WAAS avionics indicate that LNAV/VNAV or LPV service is available, then vertical guidance may be used to complete the approach using the displayed level of service. Should an outage occur during the procedure, reversion to LNAV minima may be required. As the WAAS coverage is expanded, the **W** will be removed.

PLANVIEW

The data on the planview is drawn to scale, unless one of the following three charting devices are utilized: concentric rings, scale breaks or inset box(es). In many cases, obstructions close to the airport can be depicted within the parameters of the airport sketch.

Terrain Depiction

Terrain will be depicted with contour lines in shades of brown, in the planview portion of all IAPs at airports that meet the following criteria:

- If the terrain within the planview exceeds 4,000 feet above the airport elevation, or
- If the terrain within a 6.0 nautical mile radius of the Airport Reference Point (ARP) rises to at least 2,000 feet above the airport elevation.

Approximately 1200 airports throughout the US currently meet the above criteria.

MISSED APPROACH ICONS

Boxed MAP icons, placed in the profile section, are intended to provide quick at-a-glance intuitive guidance to the pilot to supplement, not replace, the textual missed approach instructions in the briefing strip. These step-by-step instructional graphics depict direction of turn, next heading/course/bearing/track, next altitude, etc. to give the pilot the “up and out” initial steps of the missed approach.



IFR LANDING MINIMA

The United States Standard for Terminal Instrument Procedures (TERPS) is the approved criteria for formulating instrument approach procedures. Landing minima are established for six aircraft categories (ABCDE and COPTER). In the absence of COPTER MINIMA, helicopters may use the CAT A minimums of other procedures.

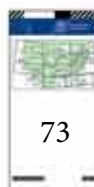



CIRCLING APPROACH OBSTACLE PROTECTED AIRSPACE

The circling MDA provides vertical clearance from obstacles when conducting a circle-to-land maneuver within the obstacle protected area. Circling approach obstacle protected areas extend laterally and longitudinally from the centerlines and ends of all runways at an airport by the distances shown in the following tables. The areas are technically defined by the tangential connection of arcs drawn at the radius distance shown from each runway end.

STANDARD CIRCLING APPROACH MANEUVERING RADIUS

Circling approach protected areas developed prior to late 2012 used the radius distances shown in the following table, expressed in nautical miles (NM), dependent on aircraft approach category. The approaches using standard circling approach areas can be identified by the absence of the **C** symbol on the circling line of minima.

Circling MDA in feet MSL	Approach Category and Circling Radius (NM)				
	CAT A	CAT B	CAT C	CAT D	CAT E
All Altitudes	1.3	1.5	1.7	2.3	4.5

C EXPANDED CIRCLING APPROACH MANEUVERING AIRSPACE RADIUS

Circling approach protected areas developed after late 2012 use the radius distance shown in the following table, expressed in nautical miles (NM), dependent on aircraft approach category, and the altitude of the circling MDA, which accounts for true airspeed increase with altitude. The approaches using expanded circling approach areas can be identified by the presence of the **C** symbol on the circling line of minima.

Circling MDA in feet MSL	Approach Category and Circling Radius (NM)				
	CAT A	CAT B	CAT C	CAT D	CAT E
1000 or less	1.3	1.7	2.7	3.6	4.5
1001-3000	1.3	1.8	2.8	3.7	4.6
3001-5000	1.3	1.8	2.9	3.8	4.8
5001-7000	1.3	1.9	3.0	4.0	5.0
7001-9000	1.4	2.0	3.2	4.2	5.3
9001 and above	1.4	2.1	3.3	4.4	5.5

TERMINAL ARRIVAL AREAS (TAAs)

The objective of the Terminal Arrival Area (TAA) is to provide a seamless transition from the enroute structure to the terminal environment for arriving aircraft equipped with Flight Management System (FMS) and/or Global Positioning System (GPS) navigational equipment. The underlying instrument approach procedure is an area navigation (RNAV) procedure. The TAA contains within it a “T” structure that normally provides for a No Procedure Turn (NoPT) for aircraft using the approach. The TAA provides the pilot and air traffic controller with a very efficient method for routing traffic into the terminal environment with little required air traffic control interface, and with minimum altitudes depicted that provide standard obstacle clearance compatible with the instrument procedure associated with it. The TAA will not be found on all RNAV procedures, particularly in areas of heavy concentration of air traffic. When the TAA is published, it replaces the MSA for that approach procedure. TAAs may appear on GPS and RNAV IAP charts.

NOTE: Additional information for the TAAs can be found in the Aeronautical Information Manual (AIM) Para 5-4-5-d.





Instrument Approach Chart Format

Pilot Briefing Information

JACKSONVILLE, FLORIDA

AL-5570 (FAA)

13010

WAAS CH 70626 W14A	APP CRS 136°	Rwy Idg THRE Apt Elev 29	7701
---------------------------------	------------------------	--	-------------

RNAV (GPS) Z RWY 14

JACKSONVILLE INTL (JAX)

For uncompensated Baro-VNAV systems, LNAV/VNAV NA below -5°C (23°F) or above 54°C (130°F). For inoperative MALSR, increase LNAV/VNAV all Cats visibility to 1½ miles and increase LNAV Cats A/B to 1 mile. DME/DME RNP-0.3 NA. Helicopter visibility reduction below ¾ SM not authorized.

MALSRS
MISSED APPROACH:
Climb to 500 then climbing left turn to 2000 direct YEJWO and hold.

ATIS 125.85	JACKSONVILLE APP CON 119.0 335.6	JACKSONVILLE TOWER 118.3 317.7	GND CON 121.9 348.6	CLNC DEL 119.5 290.275
-----------------------	--	--	-------------------------------	----------------------------------

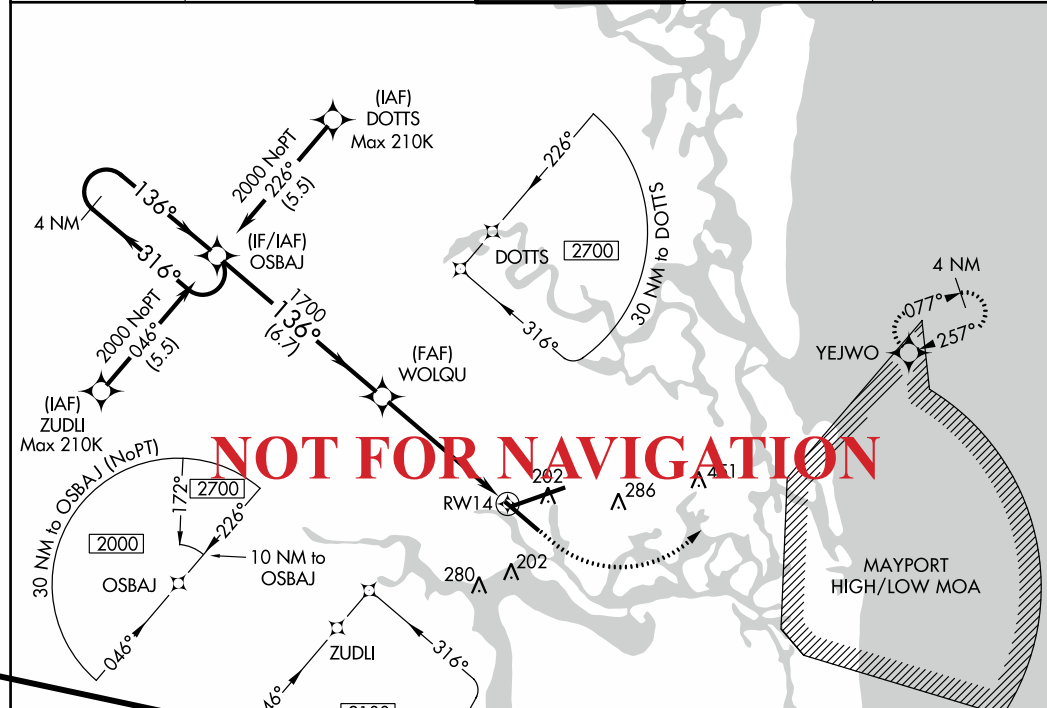

Terminal Arrival Areas (TAAs)

Missed Approach Icons



RNAV Minima

CATEGORY	A		B		C		D		
	LPV DA	227-½	200 (200-½)	363-¾	336 (400-¾)	480-¾	453 (500-¾)	480-⅞	453 (500-⅞)
LNNAV/VNAV DA									
LNNAV MDA	480-¾	453 (500-¾)			480-⅞	453 (500-⅞)			
CIRCLING	520-1	491 (500-1)			520-1½	491 (500-1½)	640-2	611 (700-2)	

JACKSONVILLE, FLORIDA
Amdt 2 10JAN13

30°30'N-81°41'W

JACKSONVILLE INTL (JAX)
RNAV (GPS) Z RWY 14



U.S. TERMINAL PROCEDURES PUBLICATION SYMBOLS

AERONAUTICAL INFORMATION

STANDARD TERMINAL ARRIVAL (STAR) CHARTS	77
DEPARTURE PROCEDURE (DP) CHARTS	77
APPROACH LIGHTING SYSTEM	78
AIRPORT DIAGRAM/SKETCH	81
INSTRUMENT APPROACH PROCEDURES PLANVIEW	83
INSTRUMENT APPROACH PROCEDURES PROFILE VIEW	85

GENERAL INFORMATION

Symbols shown are for the Terminal Procedures Publication (TPP) which includes Standard Terminal Arrival Routes (STARs), Departure Procedures (DPs), Instrument Approach Procedures (IAP) and Airport Diagrams.





U.S. TERMINAL PROCEDURES PUBLICATION

LEGEND

STANDARD TERMINAL ARRIVAL (STAR) CHARTS DEPARTURE PROCEDURE (DP) CHARTS

Applies to both STAR and DP Charts unless otherwise noted.

RADIO AIDS TO NAVIGATION

VOR (Compulsory)	VORTAC (Compulsory)	NDB (Compulsory)
VOR/DME (Compulsory)	TACAN (Compulsory)	NDB/DME (Compulsory)
VOR (Non-Compulsory)	TACAN (Non-Compulsory)	NDB (Non-Compulsory)
VOR/DME (Non-Compulsory)	NDB/DME (Non-Compulsory)	
LMM, LOM (Compass locator)	LOC (shown when installation is offset from its normal position off the end of the runway.) (DP)	LOC/DME
Marker Beacon		
Localizer Course		
SDF Course		

ROUTES

4500 MEA-Minimum Enroute Altitude
*3500 MOCA-Minimum Obstruction Clearance Altitude

270° Departure Route - Arrival Route
(65) Mileage between Radio Aids, Reporting Points, and Route Breaks

Transition Route
 R-275 Radial line and value
 Lost Communications Track

V12 J80 Airway/Jet Route Identification
DP Holding Pattern STAR Holding Pattern

(IAS) Holding pattern with max. restricted airspeed (175K) applies to all altitudes (210K) applies to altitudes above 6000' to and including 14000'

SPECIAL USE AIRSPACE

R-352 R-Restricted W-Warning
P-Prohibited A-Alert
MOA-Military Operations Area

ALTITUDES

5500 Mandatory Altitude (Cross at) 2300 Minimum Altitude (Cross at or above) 4800 Maximum Altitude (Cross at or below)

15000 12000 Block Altitude Altitude change at other than Radio Aids (STAR)

ATC CROSSING ALTITUDES (DP)

5500 (ATC) 2300 (ATC) 4800 (ATC) ATC altitude restriction

4300 1700 3000 Minimum required altitude

INDICATED AIRSPEED

175K Mandatory Airspeed 120K Minimum Airspeed 250K Maximum Airspeed

AIRPORTS

(DP) Civil Military Joint Civil-Military

MISCELLANEOUS

Changeover Point
 Distance not to scale (DP)
 International Boundary (DP)
 Takeoff Minimums and (Obstacle) Departure Procedures entry published. (DP)

(T) indicates frequency protection range (STAR) (Y) TACAN must be placed in "Y" mode to receive distance information

Frequency: 112.25 (T) ORL Chan 59 (Y) Geographic Position: N28°32.56' W81°20.10'

Underline indicates no voice transmitted on this frequency L-19, H-5 Enroute Chart Reference DME or TACAN Channel

Coordinates: N38°58.30' W89°51.50' Waypoint Name: PRAYS
Frequency: 112.7 CAP 187.1°-56.2 Identifier: 590 Reference Facility Elevation: 590 Radial-Distance (Facility to Waypoint): 590

FIXES/ATC REPORTING REQUIREMENTS

Reporting Points: N00°00.00' W00°00.00' 75 DME Mileage (when not obvious)

Fix-Compulsory and Non-Compulsory Position Report

DME fix

WAYPOINT (Compulsory) WAYPOINT (Non-Compulsory)

FLYOVER POINT

X Computer Navigation Fix (CNF) N00°00.00' W00°00.00'



U.S. TERMINAL PROCEDURES PUBLICATION

APPROACH LIGHTING SYSTEM

RUNWAY TOUCHDOWN ZONE AND CENTERLINE LIGHTING SYSTEMS

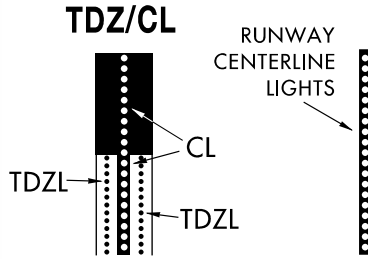

APPROACH LIGHTING SYSTEM

ALSF-2

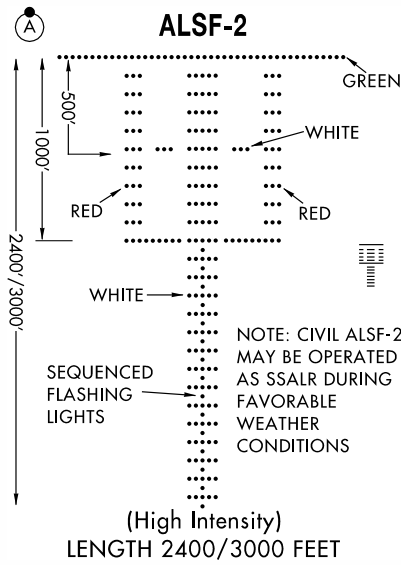

NOTE: CIVIL ALSF-2 MAY BE OPERATED AS SSALR DURING FAVORABLE WEATHER CONDITIONS

ALSF-1

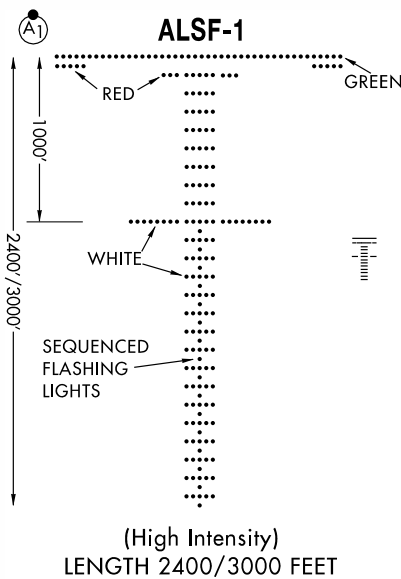

APPROACH LIGHTING SYSTEM

SHORT APPROACH LIGHTING SYSTEM

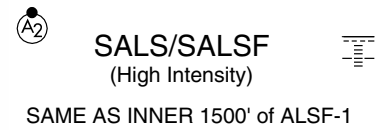

SAME AS INNER 1500' of ALSF-1

SIMPLIFIED SHORT APPROACH LIGHTING SYSTEM WITH RUNWAY ALIGNMENT INDICATOR LIGHTS

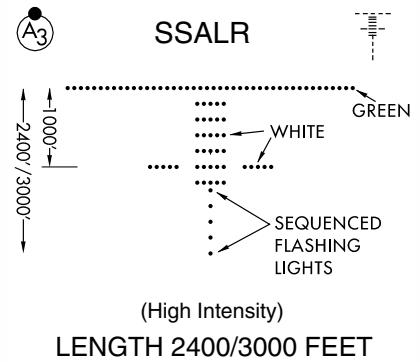

MEDIUM INTENSITY (MALS AND MALSF) OR SIMPLIFIED SHORT (SSALS AND SSALF) APPROACH LIGHTING SYSTEMS

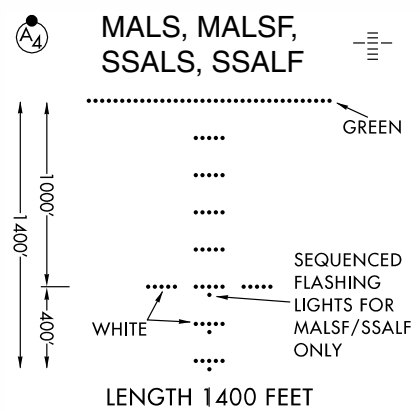

MEDIUM INTENSITY APPROACH LIGHTING SYSTEM WITH RUNWAY ALIGNMENT INDICATOR LIGHTS

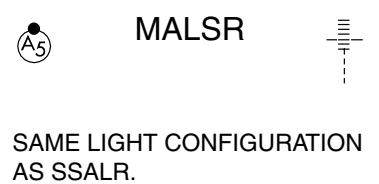

SAME LIGHT CONFIGURATION AS SSALR.

U.S. TERMINAL PROCEDURES PUBLICATION

APPROACH LIGHTING SYSTEM

OMNIDIRECTIONAL
APPROACH LIGHTING
SYSTEM

ODALS

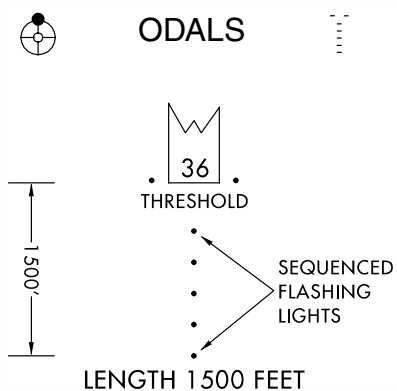

VISUAL APPROACH
SLOPE INDICATOR

VASI

VASI
VISUAL APPROACH SLOPE INDICATOR
WITH STANDARD THRESHOLD CLEARANCE
PROVIDED.

- ALL LIGHTS WHITE — TOO HIGH
- FAR LIGHTS RED
NEAR LIGHTS WHITE — ON GLIDE SLOPE
- ALL LIGHTS RED — TOO LOW

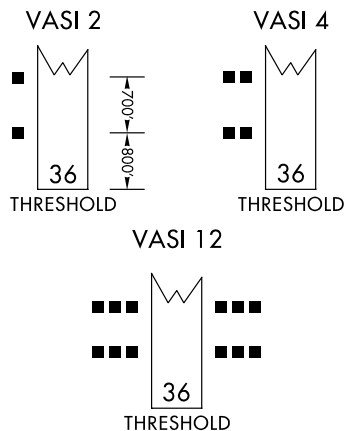

APPROACH LIGHTING SYSTEM

"T"-VISUAL APPROACH
SLOPE INDICATOR

"T"-VASI

(V₁)

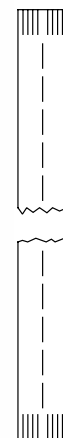

"T"-VASI

"T" ON BOTH SIDES OF RWY
ALL LIGHTS VARIABLE WHITE.
CORRECT APPROACH SLOPE-
ONLY CROSS BAR VISIBLE.
UPRIGHT "T"- FLY UP.
INVERTED "T"- FLY DOWN.
RED "T"- GROSS
UNDERSHOOT.

VISUAL APPROACH
SLOPE INDICATOR

VASI

VISUAL
APPROACH
SLOPE INDICATOR

VASI

VASI

(V₃) VISUAL APPROACH SLOPE INDICATOR
WITH A THRESHOLD CROSSING HEIGHT TO
ACCOMMODATE LONG BODIED OR JUMBO
AIRCRAFT.

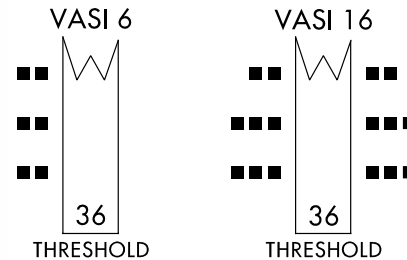

PRECISION
APPROACH PATH
INDICATOR

PAPI

PAPI

(P)

Legend: □ White ■ Red

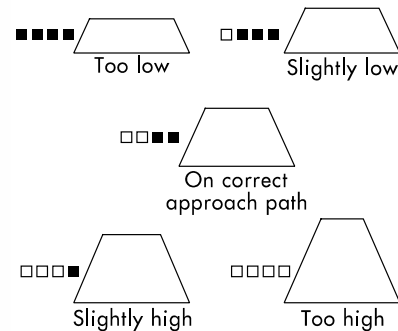

U.S. TERMINAL PROCEDURES PUBLICATION

APPROACH LIGHTING SYSTEM

PULSATING VISUAL APPROACH SLOPE INDICATOR
PVASI

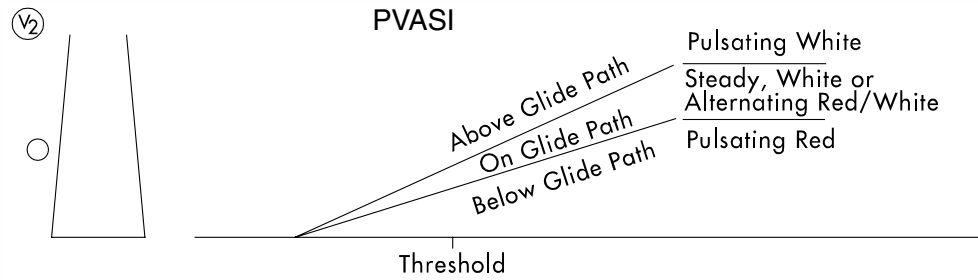

CAUTION: When viewing the pulsating visual approach slope indicators in the pulsating white or pulsating red sectors, it is possible to mistake this lighting aid for another aircraft or a ground vehicle. Pilots should exercise caution when using this type of system.

TRI-COLOR VISUAL APPROACH SLOPE INDICATOR
TRCV

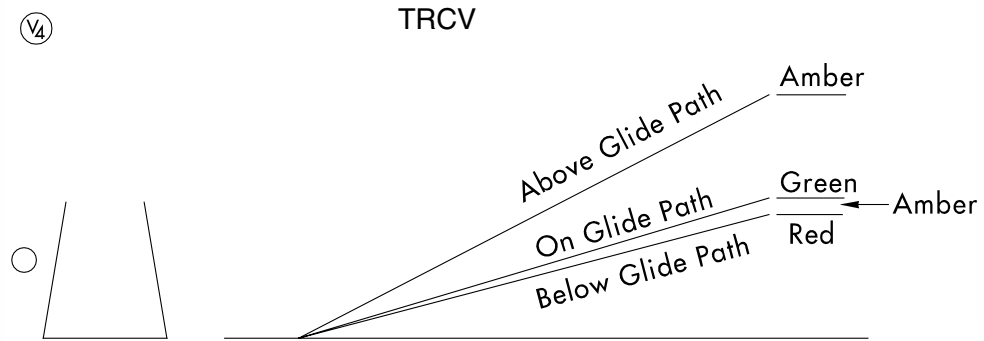

CAUTION: When the aircraft descends from green to red, the pilot may see a dark amber color during the transition from green to red.

ALIGNMENT OF ELEMENT SYSTEMS
APAP

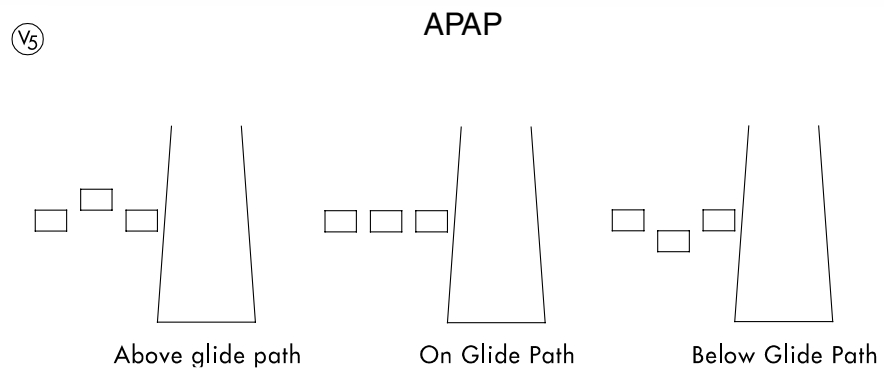

Painted panels which may be lighted at night. To use the system the pilot positions the aircraft so the elements are in alignment.



U.S. TERMINAL PROCEDURES PUBLICATION

AIRPORT DIAGRAM/SKETCH

ARRESTING GEAR

uni-directional

bi-directional

Jet Barrier

Arresting System

ARRESTING GEAR: Specific arresting gear systems; e.g., BAK12, MA-1A etc., shown on airport diagrams, not applicable to Civil Pilots. Military Pilots refer to appropriate DOD publications.

REFERENCE FEATURES

Buildings

24-Hour Self-Serve Fuel ##.

Tanks

Obstruction

Airport Beacon

Runway Radar Reflectors

Hot Spot

TWR Control Tower #

When Control Tower and Rotating Beacon are co-located, Beacon symbol will be used and further identified as TWR.

A fuel symbol is shown to indicate 24-hour self-serve fuel available, see appropriate A/FD, Alaska or Pacific Supplement for information.

Helicopter Alighting Areas

Negative Symbols used to identify Copter Procedures landing point

Runway Threshold elevation...THRE 123

Runway TDZ elevation.....TDZE 123

— 0.3% DOWN
0.8% UP — Runway Slope

(shown when runway slope equals or exceeds 0.3%)

NOTE:
Runway Slope measured to midpoint on runways 8000 feet or longer.

A **D** symbol is shown to indicate runway declared distance information available, see appropriate A/FD, Alaska or Pacific Supplement for distance information.

AIRPORT DIAGRAM/SKETCH

NOTES

U.S. Navy Optical Landing System (OLS) "OLS" location is shown because of its height of approximately 7 feet and proximity to edge of runway may create an obstruction for some types of aircraft.

Approach light symbols are shown in the Flight Information Handbook.

Airport diagram scales are variable.

True/magnetic North orientation may vary from diagram to diagram

Coordinate values are shown in 1 or ½ minute increments. They are further broken down into 6 second ticks, within each 1 minute increments.

Positional accuracy within ±600 feet unless otherwise noted on the chart.

NOTE:
All new and revised airport diagrams are shown referenced to the World Geodetic System (WGS) (noted on appropriate diagram), and may not be compatible with local coordinates published in FLIP. (Foreign Only)

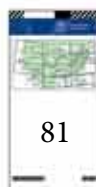



U.S. TERMINAL PROCEDURES PUBLICATION

AIRPORT DIAGRAM/SKETCH

RUNWAYS

- Hard Surface
- Other than hard surface
- Stopways, Taxiways, Parking Areas
- Displaced Threshold
- Closed Runway
- Closed Taxiway
- Under Construction
- Metal Surface

Runway length depicted is the physical length of the runway (end-to-end, including displaced thresholds if any) but excluding areas designated as stopways.

Runway Weight Bearing Capacity/or PCN Pavement Classification Number is shown as a codified expression. Refer to the appropriate Supplement/Directory for applicable codes e.g., RWY 14-32 PCN 80 F/D/X/U S-75, D-185, 2S-175, 2D-325

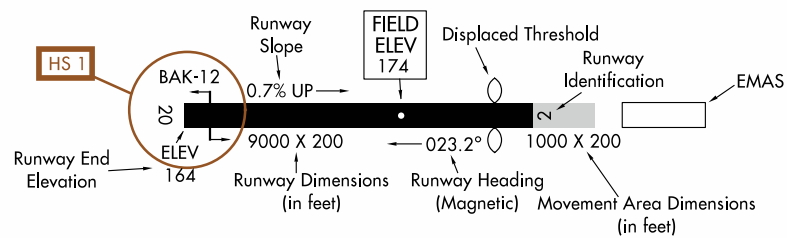

SCOPE

Airport diagrams are specifically designed to assist in the movement of ground traffic at locations with complex runway/taxiway configurations. Airport diagrams are not intended to be used for approach and landing or departure operations. For revisions to Airport Diagrams: Consult FAA Order 7910.4.





U.S. TERMINAL PROCEDURES PUBLICATION

INSTRUMENT APPROACH PROCEDURES PLANVIEW

TERMINAL ROUTES

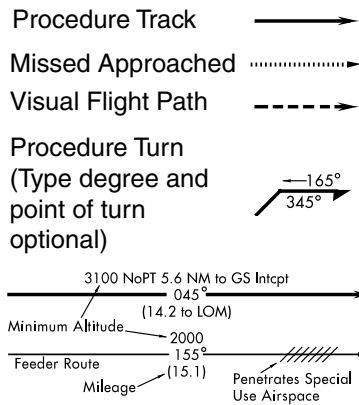

HOLDING PATTERNS

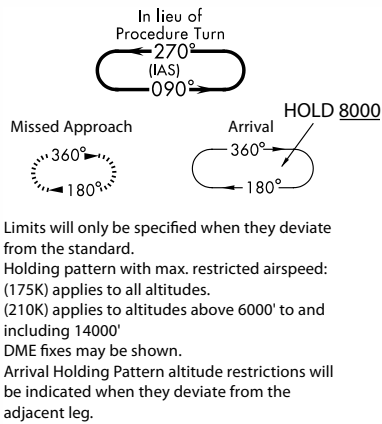

FIXES/ATC REPORTING REQUIREMENTS

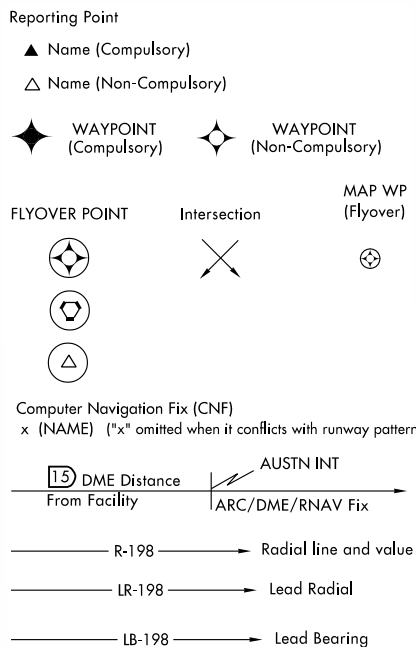

INSTRUMENT APPROACH PROCEDURES PLANVIEW

RADIO AIDS TO NAVIGATIONS

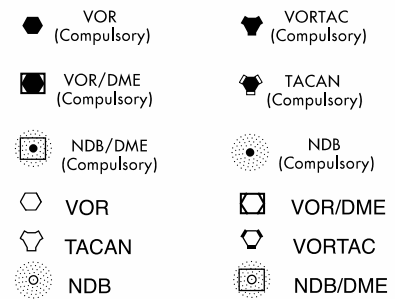

LOM/LMM (Compass locator at Outer/Middle Marker)

Marker Beacon

Localizer (LOC/LDA) Right side shading-Front Course; Left side shading-Back Course

SDF Course 180° MLS Approach Azimuth

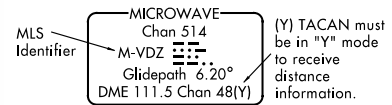

LOC/DME

LOC/LDA/SDF/MLS Transmitter (shown when installation is offset from its normal position off the end of the runway.)

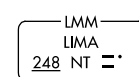
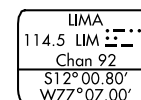
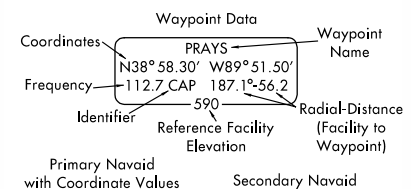
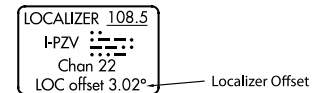

MINIMUM SAFE ALTITUDE

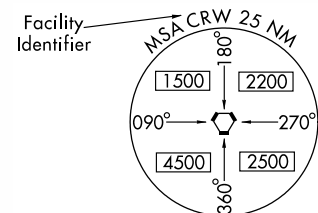

(arrows on distance circle identify sectors)



U.S. TERMINAL PROCEDURES PUBLICATION

INSTRUMENT APPROACH PROCEDURES PLANVIEW

TERMINAL ARRIVAL AREAS

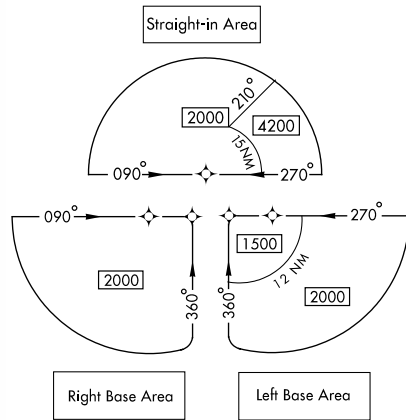

Minimum MSL altitudes are charted within each of these defined areas/subdivisions that provide at least 1,000 feet of obstacle clearance, or more as necessary in mountainous areas.

SPECIAL USE AIRSPACE

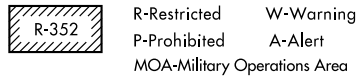

OBSTACLES

- Spot Elevation
- Highest Spot Elevation
- △ Obstacle
- △ Highest Obstacle
- ± Doubtful accuracy

ALTITUDES

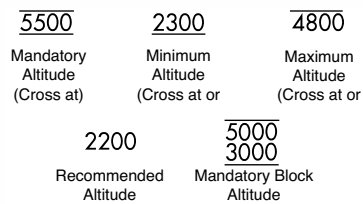

INSTRUMENT APPROACH PROCEDURES PLANVIEW

MISCELLANEOUS

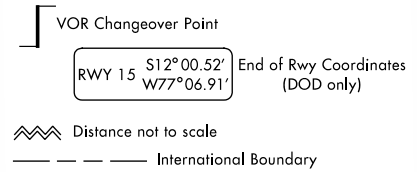

Miscellaneous Symbols
 Miscellaneous Symbols are occasionally used as a reference mark to connect information from two different areas on a chart.



AIRPORTS

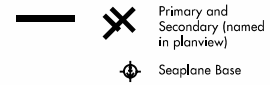

INDICATED AIRSPEED

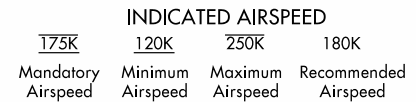



U.S. TERMINAL PROCEDURES PUBLICATION

INSTRUMENT APPROACH PROCEDURES PROFILE VIEW

PROFILE VIEW

Two different methods are used for vertical guidance:

a. "GS" indicates an electronic glide slope or barometric vertical guidance is present. In the case of an Instrument Landing System (ILS) and Wide Area Augmentation System (WAAS) LPV approach procedures, an electronic signal provides vertical guidance. Barometric vertical guidance is provided for RNP and LNAV/VNAV instrument approach procedures. All ILS, LPV, RNP, and LNAV/VNAV will be in this format $\text{GS } 3.00^\circ$, located in the lower left or right corner.

b. Other charts without electronic or barometric vertical guidance will be in this format $\text{TCH } 55^\circ$, indicating a non-precision vertical descent angle to assist in preventing controlled flight into terrain. On Civil (FAA) procedures, this information is placed above or below the procedure track following the fix it is based on.

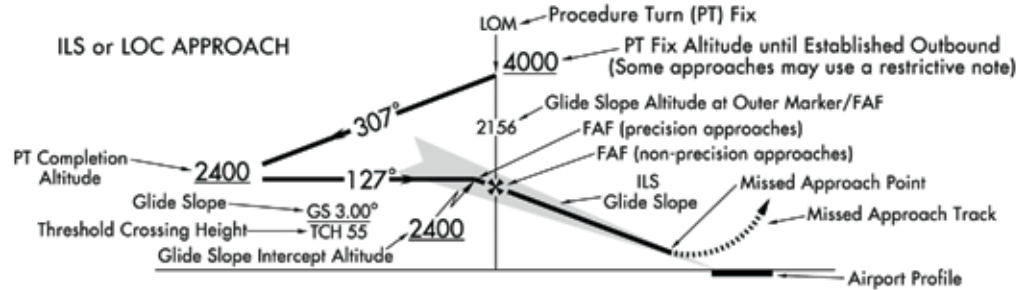

MLS APPROACH

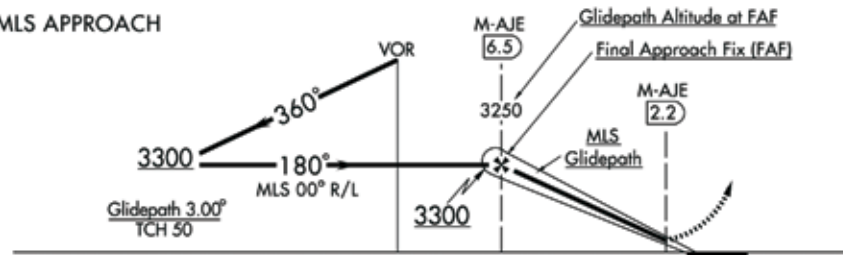

RNAV APPROACH

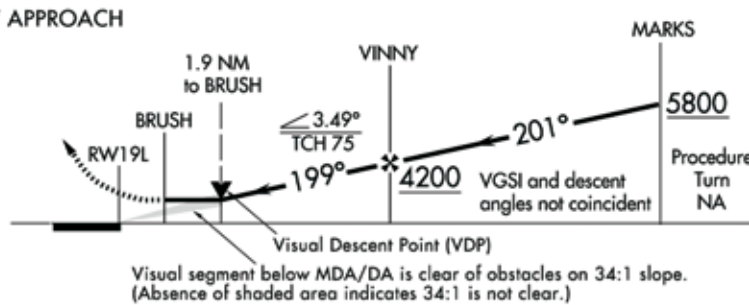

NON PRECISION

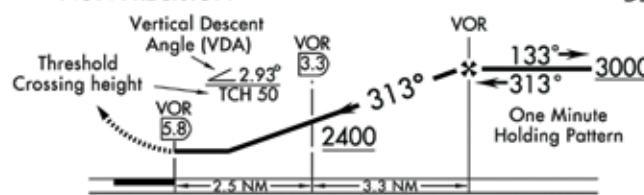

DESCENT FROM HOLDING PATTERN

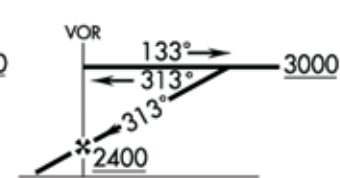

ALTITUDES

<u>5500</u> Mandatory Altitude	<u>3000</u> Recommended Altitude
<u>2500</u> Minimum Altitude	<u>5000</u> Mandatory Block Altitude
<u>4300</u> Maximum Altitude	<u>3000</u> Altitude

PROFILE SYMBOLS

Glide Slope/Glide Path Intercept Altitude and final approach fix for vertically guided approach procedures.	Visual Flight Path
Visual Descent Point (VDP)	Note: Facilities and waypoints are depicted as a solid vertical line while fixes and intersections are depicted as a dashed vertical line.



